



























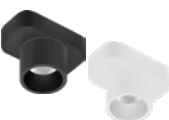









## 04. Sistemas Lineales - CARRIL MAGNÉTICO

### ÍNDICE VISUAL

 <p>   <b>RBOLA-10W</b> Pg. 308         </p>	 <p>   <b>R Globo-5W</b> Pg. 311         </p>	 <p>   <b>R13-20W</b> Pg. 312         </p>	 <p>   <b>R14-20W</b> Pg. 312         </p>	 <p>   <b>R1-18W</b> Pg. 314         </p>
 <p>   <b>R1-54W</b> Pg. 314         </p>	 <p>   <b>R2-18W</b> Pg. 314         </p>	 <p>   <b>R2-54W</b> Pg. 314         </p>	 <p>   <b>R1-MINI-12W</b> Pg. 316         </p>	 <p>   <b>R1-MINI-24W</b> Pg. 316         </p>
 <p>   <b>R2-MINI-10W</b> Pg. 317         </p>	 <p>   <b>R2-MINI-30W</b> Pg. 317         </p>	 <p>   <b>R-SPOT1-3W</b> Pg. 318         </p>	 <p>   <b>R-SPOT2-3W</b> Pg. 319         </p>	 <p>   <b>R15-3W</b> Pg. 319         </p>
 <p>   <b>R3-18W</b> Pg. 321         </p>	 <p>   <b>R4-6W</b> Pg. 321         </p>	 <p>   <b>R4-18W</b> Pg. 321         </p>	 <p>   <b>R5-5W / 10W / 24W</b> Pg. 325         </p>	 <p>   <b>R6-10W</b> Pg. 325         </p>
 <p>   <b>R7-12W</b> Pg. 327         </p>	 <p>   <b>R8-5W</b> Pg. 327         </p>	 <p>   <b>R9-18W</b> Pg. 328         </p>	 <p>   <b>R10-10W</b> Pg. 331         </p>	 <p>   <b>R11-6W</b> Pg. 332         </p>

 <p>   <b>R11-12W</b>                      Pg. 332                 </p>	 <p>   <b>R11-24W</b>                      Pg. 332                 </p>	 <p>   <b>R12-8W</b>                      Pg. 335                 </p>	 <p>   <b>M-NEÓN 360°-35W</b>                      Pg. 336                 </p>	 <p>   <b>RAC MINI</b>                      ACCESORIOS                      Pg. 337                 </p>
 <p>   <b>RAC</b>                      ACCESORIOS RAC                      Pg. 338                 </p>	 <p>   <b>M1000</b>                      ACCESORIOS M1000                      Pg. 339-340                 </p>	 <p>   <b>REC</b>                      ACCESORIOS REC                      Pg. 341                 </p>	 <p>   <b>RIC</b>                      ACCESORIOS RIC                      Pg. 341                 </p>	 <p>   <b>CONECTORES</b>                      Y ACCESORIOS                      Pg. 342                 </p>
 <p>   <b>RUNION 360°</b>                      Pg. 343                 </p>	 <p> <b>DRIVERS</b>                      Pg. 344                 </p>			

ESFERA PARA CARRIL MAGNÉTICO



**OSRAM**

**MAGNÉTICO**

Ø150 x 193 mm

OPCIONES



■ 19: Negro

● 2700K

● Cálido

● Neutro



**RBOLA**

Lúmenes chip: RBOLA-10W: 720 lm

Ref.	T. <sup>a</sup> Color	Acabado	P.V.
RBOLA-10W-19	2,7, 3K o 4K	Negro (esfera blanca)	46,30 €

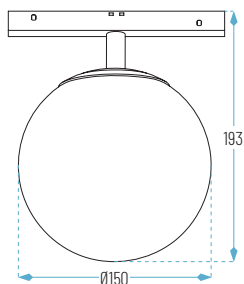





OPCIONES **WiFi** **E**

Ø100 x 100 mm

**MAGNÉTICO**

MacAdam  
**3-STEP**

Flicker  
Free

**48V**

**CE**

RoHS

**IP  
20**

**CRI  
>90**

**RGLOBO 5W**

Lúmenes chip: RGLOBO-5W: 423 lm

Ref.	T. <sup>a</sup> Color	Acabado	P.V.
RGLOBO-5W-01-27K	2700 K	Blanco	<b>59,48 €</b>
RGLOBO-5W-01-3K	3000 K	Blanco	<b>59,48 €</b>
RGLOBO-5W-01-4K	4000 K	Blanco	<b>59,48 €</b>
RGLOBO-5W-19-27K	2700 K	Negro	<b>59,48 €</b>
RGLOBO-5W-19-3K	3000 K	Negro	<b>59,48 €</b>
RGLOBO-5W-19-4K	4000 K	Negro	<b>59,48 €</b>

01: Blanco

19: Negro

2700K

Cálido

Neutro

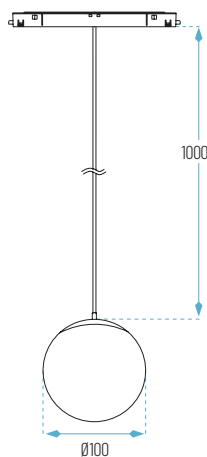

## LUZ PARA ESQUINA HORIZONTAL

**IP 20** **48V** **OSRAM 2835** **MAGNÉTICO** 315 x 300 x 22,5 mm OPCIONES **WiFi**

01: Blanco arenado

19: Negro arenado

2700K

Cálido

Neutro

### R13

Válido como unión de electricidad 48V entre carriles.

Ref.	Potencia	T. <sup>a</sup> Color	Acabado	P.V.
R13-01	20W	2,7, 3K o 4K	Blanco Arenado	<b>79,34 €</b>
R13-19	20W	2,7, 3K o 4K	Negro Arenado	<b>79,34 €</b>

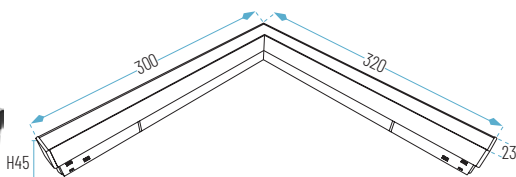

Actúa como conector entre carriles

## LUZ PARA ESQUINA VERTICAL

**IP 20** **48V** **OSRAM 2835** **MAGNÉTICO** 315 x 22,5 x 300 mm OPCIONES **WiFi**

01: Blanco arenado

19: Negro arenado

2700K

Cálido

Neutro

### R14

Válido como unión de electricidad 48V entre carriles.

Ref.	Potencia	T. <sup>a</sup> Color	Acabado	P.V.
R14-01	20W	2,7, 3K o 4K	Blanco Arenado	<b>79,34 €</b>
R14-19	20W	2,7, 3K o 4K	Negro Arenado	<b>79,34 €</b>

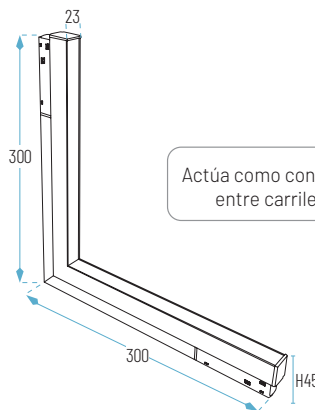

Actúa como conector entre carriles



## LINEAL MAGNÉTICO



18W: L328 x W23 x H45 mm  
54W: L976 x W23 x H45 mm

01: Blanco arenado

19: Negro arenado

2700K

Cálido

Neutro

Principal



Opciones

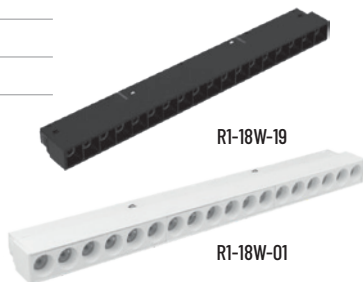

R1-18W-19

R1-18W-01

### R1-18W Y 54W

Válido como unión de electricidad 48V entre carriles.

Lúmenes aplicación: 18W 1800 lm

Lúmenes aplicación: 54W 5400 lm

Ref.	Potencia	T. <sup>a</sup> Color	Acabado	P.V.
R1-18W-01	18 W	2,7K, 3K o 4K	Blanco	35,60 €
R1-18W-19	18 W	2,7K, 3K o 4K	Negro	35,60 €
R1-54W-01	54 W	2,7K, 3K o 4K	Blanco	88,54 €
R1-54W-19	54 W	2,7K, 3K o 4K	Negro	88,54 €

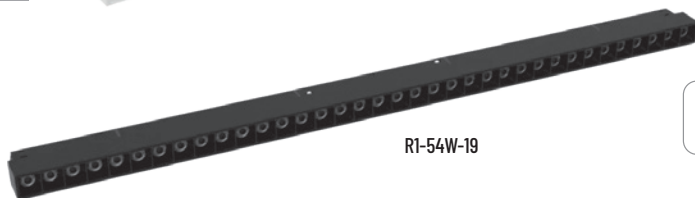

R1-54W-19

Actúa como conector entre carriles



18W: L328 x W23 x H45 mm  
54W: L976 x W23 x H45 mm

01: Blanco arenado

19: Negro arenado

2700K

Cálido

Neutro

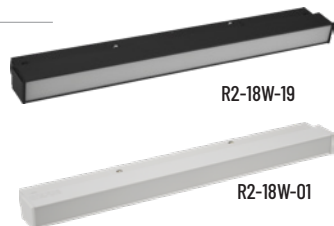

R2-18W-19

R2-18W-01

### R2-18W Y 54W

Válido como unión de electricidad 48V entre carriles.

Lúmenes aplicación: 18W 1800 lm

Lúmenes aplicación: 54W 5400 lm

Ref.	Potencia	T. <sup>a</sup> Color	Acabado	P.V.
R2-18W-01	18 W	2,7, 3K o 4K	Blanco	32,44 €
R2-18W-19	18 W	2,7, 3K o 4K	Negro	32,44 €
R2-54W-01	54 W	2,7, 3K o 4K	Blanco	77,14 €
R2-54W-19	54 W	2,7, 3K o 4K	Negro	77,14 €

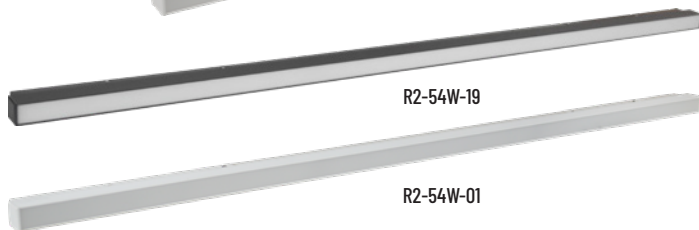

R2-54W-19

R2-54W-01

Actúa como conector entre carriles



## LUMINARIA LINEAL PARA CARRIL MAGNÉTICO

IP 20
CRI 90
48V
RoHS
CE
Flicker Free
MacAdam 3-STEP
MAGNÉTICO
12W: 350 × 16 × 18 mm
24W: 610 × 16 × 18 mm
OPCIONES
WiFi
E

### R1-MINI-12W / 24W

Ref.	Potencia	T. <sup>a</sup> Color	Acabado	P.V.
R1-MINI-12W-01	12 W	2,7K, 3K o 4K	Blanco	25,04 €
R1-MINI-12W-19	12 W	2,7K, 3K o 4K	Negro	25,04 €
R1-MINI-24W-01	24 W	2,7K, 3K o 4K	Blanco	42,64 €
R1-MINI-24W-19	24 W	2,7K, 3K o 4K	Negro	42,64 €

- 01: Blanco arenado
- 19: Negro arenado
- 2700K
- Cálido
- Neutro



R1-MINI-12W

Lúmenes aplicación: 12W 1080 lm

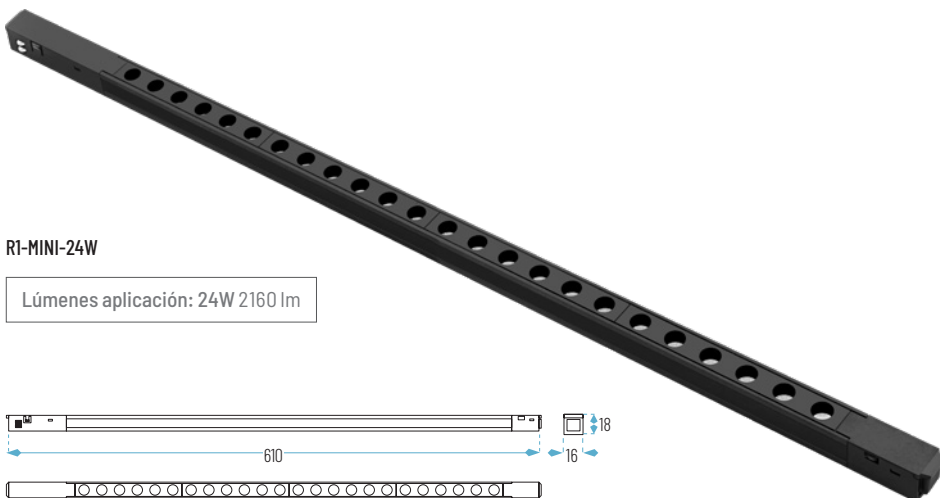
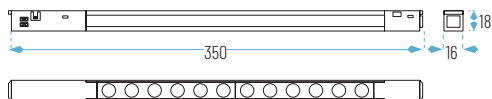

R1-MINI-24W

Lúmenes aplicación: 24W 2160 lm

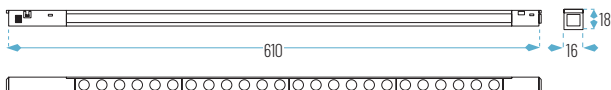

OPCIONES **WiFi** **E**

10W: 405 × 16 × 18 mm  
30W: 1040 × 16 × 18 mm

**MAGNÉTICO**

MacAdam  
**3-STEP**

Flicker  
Free



**48V**

**CE**

RoHS

**IP 20**

**CRI >90**

R2-MINI-10W / 30W

Ref.	Potencia	T. <sup>a</sup> Color	Acabado	P.V.
R2-MINI-10W-01	10 W	2,7K, 3K o 4K	Blanco	<b>25,04 €</b>
R2-MINI-10W-19	10 W	2,7K, 3K o 4K	Negro	<b>25,04 €</b>
R2-MINI-30W-01	30 W	2,7K, 3K o 4K	Blanco	<b>48,56 €</b>
R2-MINI-30W-19	30 W	2,7K, 3K o 4K	Negro	<b>48,56 €</b>

01: Blanco arenado

19: Negro arenado

2700K

Cálido

Neutro

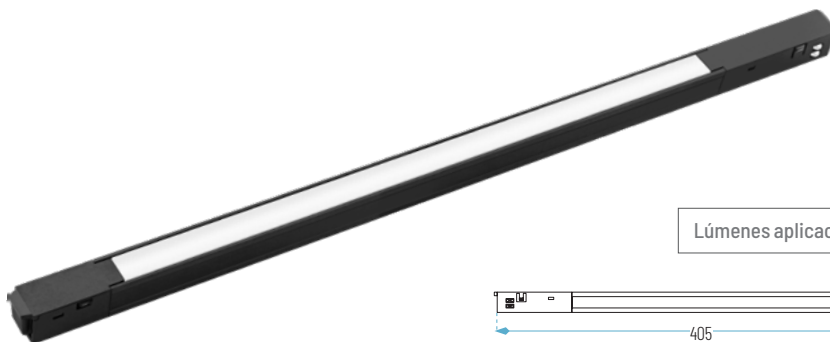

R2-MINI-10W

Lúmenes aplicación: 10W 900 lm

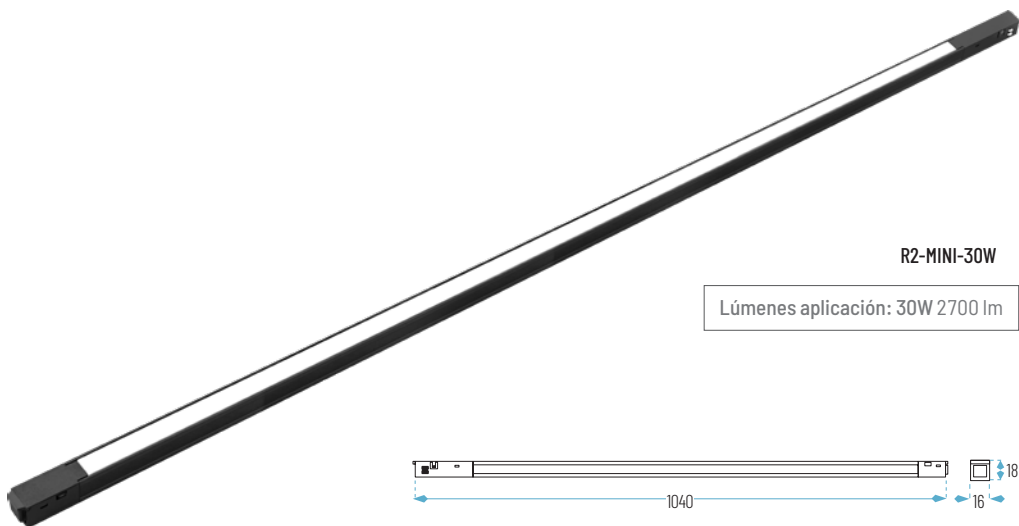
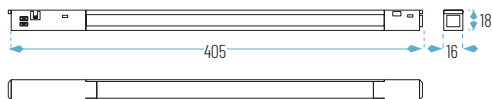

R2-MINI-30W

Lúmenes aplicación: 30W 2700 lm

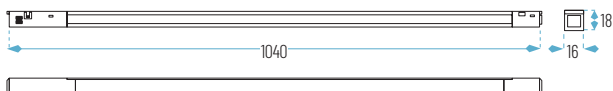

SPOTLIGHT PARA CARRIL MAGNÉTICO

**IP 20** **CRI 90** **48V** **RoHS** **CE** **Flicker Free** **MacAdam 3-STEP** **MAGNÉTICO** 35 × 22 × 45 mm **OPCIONES** **WiFi** **E**

- 01: Blanco arenado
- 19: Negro arenado
- 2700K
- Cálido
- Neutro



R SPOT 1-3W

Lúmenes aplicación: 3W 270 lm

Ref.	T. <sup>a</sup> Color	Acabado	P.V.
R-SPOT1-3W-01	2,7K, 3K o 4K	Blanco	22,90 €
R-SPOT1-3W-19	2,7K, 3K o 4K	Negro	22,90 €



R-SPOT1-3W-01



R-SPOT1-3W-19

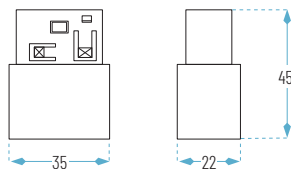

OPCIONES **WiFi** **E**

35 × 22 × 35 mm

**MAGNÉTICO**

MacAdam  
**3-STEP**

Flicker  
Free



**48V**

**CE**

RoHS

**IP 20**

**CRI >90**

**R SPOT 2-3W**

Lúmenes aplicación: 3W 270 lm

Ref.	T.ª Color	Acabado	P.V.
R-SPOT2-3W-01	2,7K, 3K o 4K	Blanco	<b>22,90 €</b>
R-SPOT2-3W-19	2,7K, 3K o 4K	Negro	<b>22,90 €</b>

01: Blanco arenado

19: Negro arenado

2700K

Cálido

Neutro



R-SPOT2-3W-01



R-SPOT2-3W-19

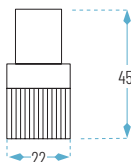
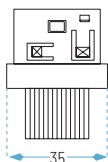

**R15-3W**

Ref.	T.ª Color	Acabado	P.V.
R15-3W-01	2,7K, 3K o 4K	Blanco	<b>42,94 €</b>
R15-3W-19	2,7K, 3K o 4K	Negro	<b>42,94 €</b>

LUZ DE LECTURA PARA CARRIL MAGNÉTICO

OPCIONES **WiFi** **E**

Ø20 × 60 mm



MacAdam  
**3-STEP**

Flicker  
Free



**48V**

**CE**

RoHS

**IP 20**

**CRI >90**

01: Blanco arenado

19: Negro arenado

2700K

Cálido

Neutro



R15-3W-01

R15-3W-19

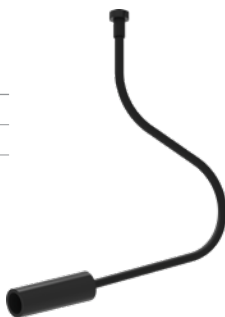



L340 x W35 x H75 mm



**R3-18W LINEAL ORIENTABLE**

Lúmenes chip: 2600 lm  
Lúmenes aplicación: 1800 lm

Ref.	T. <sup>a</sup> Color	Acabado	P.V.
R3-18W-01	2,7K, 3K o 4K	Blanco	<b>58,85 €</b>
R3-18W-19	2,7K, 3K o 4K	Negro	<b>58,85 €</b>

- 01: Blanco arenado
- 19: Negro arenado
- 2700K
- Cálido
- Neutro

Principal



Opciones



R3-18W-19

6W: L112 x W23 x H115 mm  
18W: L328x W23 x H115 mm



**R4-6W Y 18W FOCO LÍNEA**

Lúmenes chip: 6 W 980 lm  
Lumens aplicación: 6W 600 lm

Lúmenes chip: 18 W 2760 lm  
Lúmenes aplicación: 18 W 1800 lm

Ref.	T. <sup>a</sup> Color	Acabado	P.V.
R4-6W-01	3K o 4K	Blanco	<b>27,89 €</b>
R4-6W-19	3K o 4K	Negro	<b>27,89 €</b>
R4-18W-01	3K o 4K	Blanco	<b>42,00 €</b>
R4-18W-19	3K o 4K	Negro	<b>42,00 €</b>

- 01: Blanco arenado
- 19: Negro arenado
- Cálido
- Neutro

Principal



Opciones



R4-6W-01



R4-18W-19

LINEAL MAGNÉTICO

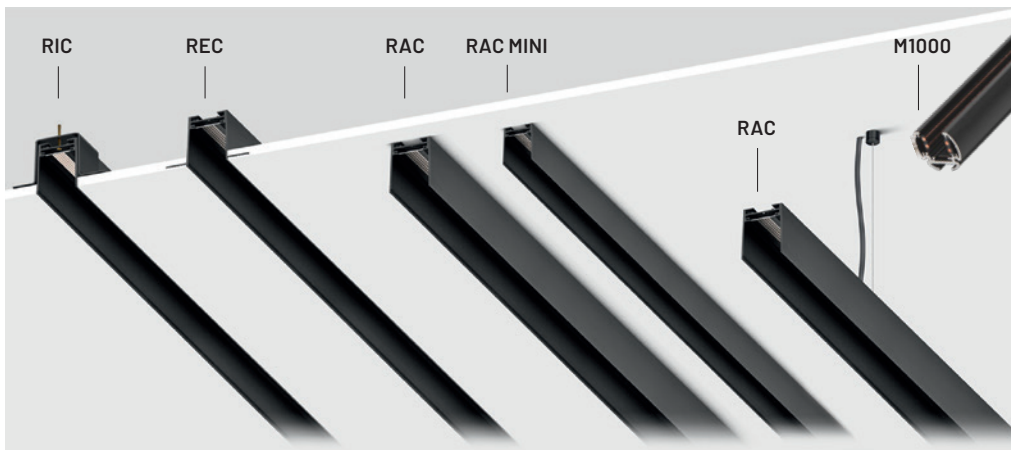





**5W:** Ø35 x H80 mm    **24W:** Ø65 x H140 mm  
**10W:** Ø45 x H100 mm

**MAGNÉTICO** **OSRAM**  **48V** **CRI 90** **CE** **RoHS** **IP 20**

**R5-5W, 10W Y 24W FOCOS**

Lúmenes aplicación:  
 5W 450 lm  
 10W 900 lm  
 24W 2160 lm



R5-5W-01

- 01: Blanco arenado
- 19: Negro arenado
- 2700K
- Cálido
- Neutro



Ref.	T.ª Color	Acabado	P.V.
R5-5W-01	2,7K, 3K o 4K	Blanco	<b>31,84 €</b>
R5-5W-19	2,7K, 3K o 4K	Negro	<b>31,84 €</b>
R5-10W-01	2,7K, 3K o 4K	Blanco	<b>36,44 €</b>
R5-10W-19	2,7K, 3K o 4K	Negro	<b>36,44 €</b>
R5-24W-01	2,7K, 3K o 4K	Blanco	<b>53,94 €</b>
R5-24W-19	2,7K, 3K o 4K	Negro	<b>53,94 €</b>



R5-10W-19



R5-24W-19

Ø50 x H300 mm

**MAGNÉTICO** **OSRAM** **48V** **CRI 90** **CE** **RoHS** **IP 20**

**R6-10W COLGANTE CARRIL MAGNÉTICO**

Lúmenes chip: 1450 lm  
 Lúmenes aplicación: 760 lm

Ref.	T.ª Color	Acabado	P.V.
R6-10W-01	2,7K, 3K o 4K	Blanco	<b>48,44 €</b>
R6-10W-19	2,7K, 3K o 4K	Negro	<b>48,44 €</b>

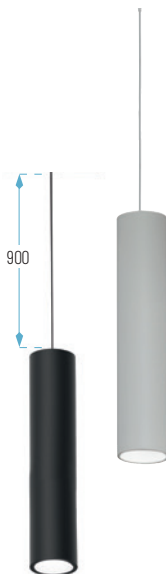

- 01: Blanco arenado
- 19: Negro arenado
- 2700K
- Cálido
- Neutro





∅100 x H100 mm

MAGNÉTICO

OSRAM



48V

CRI 90



IP 20

R7-12W BOLA

Lúmenes chip: 1300 lm  
Lúmenes aplicación: 960 lm

Ref.	T.ª Color	Acabado	P.V.
R7-12W-01	2,7K, 3K o 4K	Blanco	57,34 €
R7-12W-19	2,7K, 3K o 4K	Negro	57,34 €

900

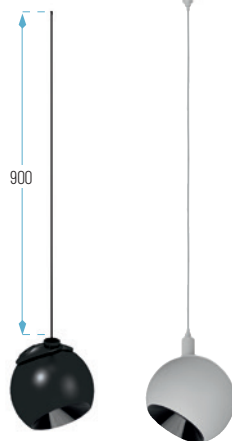

01: Blanco arenado

19: Negro arenado

2700K

Cálido

Neutro



∅85 x H75 mm

MAGNÉTICO

OSRAM

48V

CRI 90



IP 20

R8-5W CAMPANA

Lúmenes chip: 700 lm  
Lúmenes aplicación: 500 lm

Ref.	T.ª Color	Acabado	P.V.
R8-5W-01	2,7K, 3K o 4K	Blanco	48,44 €
R8-5W-19	2,7K, 3K o 4K	Negro	48,44 €

900

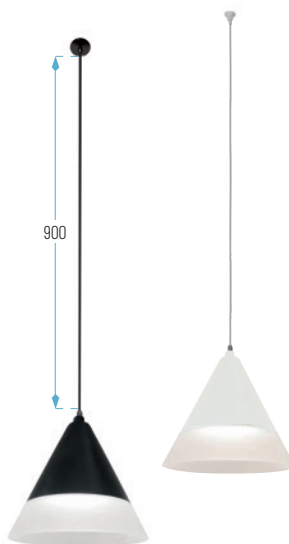

01: Blanco arenado

19: Negro arenado

2700K

Cálido

Neutro



## FOCO MAGNÉTICO

IP 20
CRI >90
48V
RoHS
CE
OSRAM
MAGNÉTICO
Ø180 x 35 mm
OPCIONES
WiFi
E

- 01: Blanco
- 19: Negro
- 2700K
- Cálido
- Neutro



R9-18W-01



R9-18W-19

### R9

Lúmenes chip: R9-18W: 1744 lm

Ref.	T.º Color	Acabado	P.V.
R9-18W-01	2,7K, 3K o 4K	Blanco	112,50 €
R9-18W-19	2,7K, 3K o 4K	Negro	112,50 €

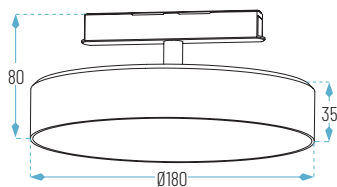



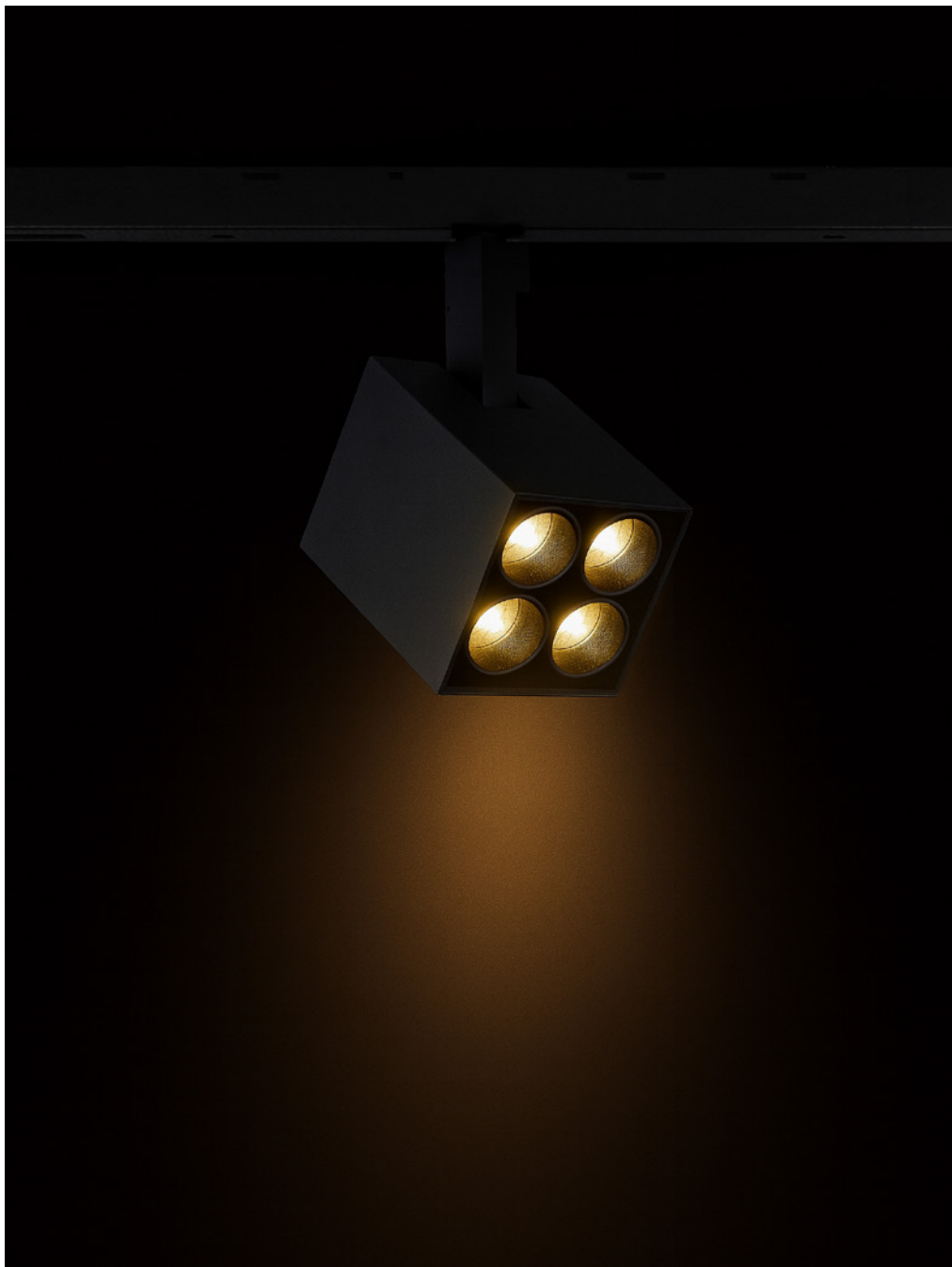

OPCIONES **WiFi** **E**

66 x 66 x 80 mm

MAGNÉTICO

OSRAM



48V

CRI >90

IP 20

- 19: Negro
- 2700K
- Cálido
- Neutro

Principal



Opciones



### R10

Ref.	T.º Color	Acabado	P.V.
R10-10W-19	2,7K, 3K o 4K	Negro	46,66 €

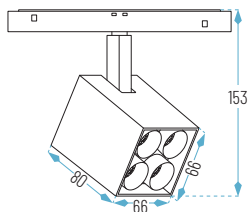

### HERA

• Otros productos de la familia

Empotrar técnica

Superficie técnica



HERA-S



HERA-Q1-19-10W



HERA-Q2-19-20W



HERA-Q3-19-10W

HERA-Q4-19-20W

## FOCO MAGNÉTICO



6W: Ø68 x 66 mm  
 12W: Ø90 x 72 mm  
 24W: Ø105 x 73 mm



- 19: Negro
- 2700K
- Cálido
- Neutro

Principal



Opciones



### R11

Ref.	T. <sup>a</sup> Color	Acabado	P.V.
R11-6W-19	2,7K, 3K o 4K	Negro	33,20 €
R11-12W-19	2,7K, 3K o 4K	Negro	42,45 €
R11-24W-19	2,7K, 3K o 4K	Negro	53,36 €

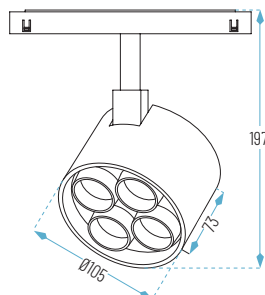
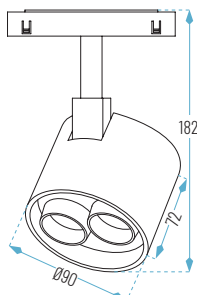
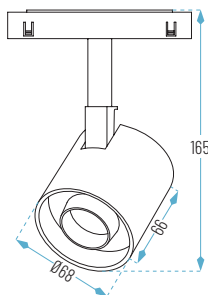

### HERA

• Otros productos de la familia

Empotrar técnica

Superficie técnica



HERA-FE1-19-6W

HERA-FE2-19-24W

HERA-FS1-19-6W

HERA-FS2-19-24W

HERA-R1-19-24W

HERA-R2-19-35W





OPCIONES **WiFi** **E**

118 x 54 x 60 mm

MAGNÉTICO

OSRAM

CE

RoHS

48V

CRI >90

IP 20



■ 19: Negro

● 2700K

● Cálido

● Neutro



R12-8W-19

R12-8W-19 + RAC MINI

## R12

Compatible solo con RAC-MINI

Ref.	T. <sup>a</sup> Color	Acabado	P.V.
R12-8W-19	2,7K, 3K o 4K	Negro	<b>35,26 €</b>

Lúmenes: R12-3K: 523 lm

Lúmenes: R12-4K: 620 lm

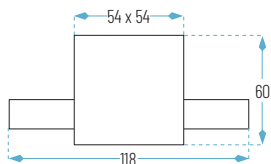

## NEON 360° PARA CARRIL MAGNÉTICO

**IP 65** **240 led/m**

**48V**



**MAGNÉTICO**

**35W**

1500 x Ø22 mm

● Cálido

● Neutro



### M NEÓN 360° 35W

Lúmenes chip: 700 lm  
Lúmenes aplicación: 500 lm

Ref.	Medida	P.V.
M-NEON 360-35W-3K	1,5 m	83,60 €
M-NEON 360-35W-4K	1,5 m	83,60 €



2000 x 27,1 x 30,6 mm



MAGNÉTICO

48V



RAC-MINI-19



RAC-MINI-01

01: Blanco

19: Negro

RAC MINI

•Tapas laterales incluidas

Ref.	Acabado	P.V.
RAC-MINI-01	Blanco	52,16 €
RAC-MINI-19	Negro	52,16 €

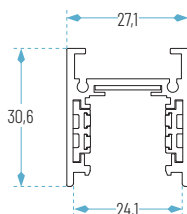

RM-H: 102 x 102 x 31 mm  
RM-V: 104 x 104 x 27 mm



MAGNÉTICO

48V



ACCESORIOS RAC MINI



RM-H-19

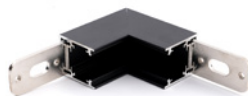

RM-V-19

01: Blanco

19: Negro

Ref.	Acabado	P.V.
RM-H-01	Blanco	6,46 €
RM-H-19	Negro	6,46 €

Ref.	Acabado	P.V.
RM-V-01	Blanco	4,30 €
RM-V-19	Negro	4,30 €

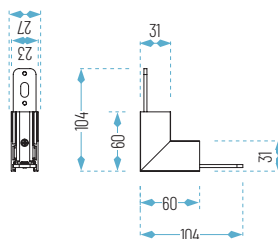
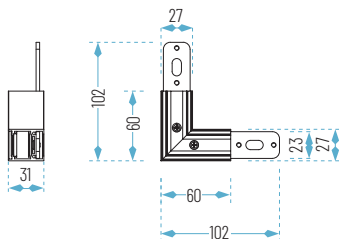

## CARRIL MAGNÉTICO COLGANTE / SUPERFICIE

IP  
20

48V



MAGNÉTICO

1m: 1000 x 26,3 x 53,7 mm

2m: 2000 x 26,3 x 53,7 mm

□ 01: Blanco arenado

■ 19: Negro arenado



### RAC

•Tapas laterales y frontal incluidas

Ref.	Acabado	P.V.
RAC-01-1M	Blanco	33,40 €
RAC-19-1M	Negro	33,40 €
RAC-01-2M	Blanco	67,00 €
RAC-19-2M	Negro	67,00 €

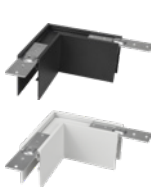

Conexión L



Conexión P

### ACCESORIOS SERIE RAC MAGNÉTICO

Ref.	Descripción	Acabado	P.V.
RAC-01-L	Conexión "L" horizontal	Blanco	12,00 €
RAC-19-L	Conexión "L" horizontal	Negro	12,00 €
RAC-01-P	Conexión "P" vertical (pared, techo)	Blanco	12,00 €
RAC-19-P	Conexión "P" vertical (pared, techo)	Negro	12,00 €

2000 x Ø32 x 26 mm

MAGNÉTICO

Máx. 500 W

CE

RoHS

48V

IP 20

01: Blanco

19: Negro

M1000-19



M1000

Ref.	Acabado	P.V.
M1000-01	Blanco	63,00 €
M1000-19	Negro	63,00 €



M1000-01

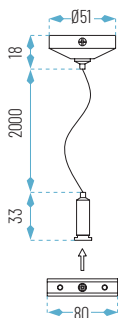
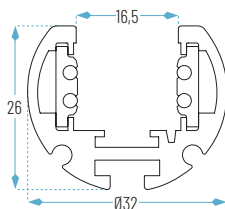

M-1000-COL-01



M-1000-COL-19

ACCESORIOS M1000

Ref.	Acabado	P.V.
M-1000-COL-01	Blanco	8,90 €
M-1000-COL-19	Negro	8,90 €

### ACCESORIOS CARRIL MAGNÉTICO

**IP**  
20

**48V**

**RoHS**

**CE**

**MAX**  
500 W

**MAGNÉTICO**

M-H: 68 x 68 x 26 mm

M-V: 32 x 68 x 68 mm

□ 01: Blanco

■ 19: Negro



M-H-1000-19



M-H-1000-01



M-V-1000-19



M-V-1000-01

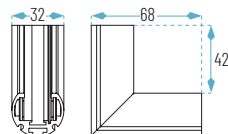
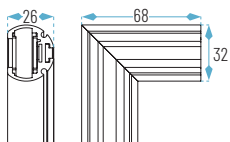

Ref.	Acabado	P.V.
M-H-1000-01	Blanco	12,50 €
M-H-1000-19	Negro	12,50 €
M-V-1000-01	Blanco	12,50 €
M-V-1000-19	Negro	12,50 €

Ref.	Acabado	P.V.
RM-COL	Acero	6,30 €
RM-COL-01	Blanco	9,30 €
RM-COL-19	Negro	9,30 €



RM-COL



RM-COL (01 o 19)

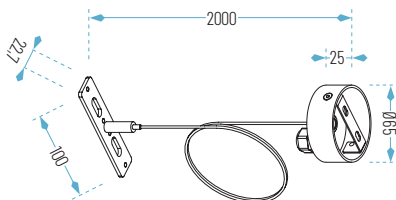
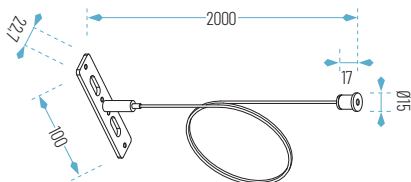

1m: 1000 x 64,3 x 53,7 mm  
Corte: 1010 x 30 x 50 mm

2m: 2000 x 64,3 x 53,7 mm  
Corte: 2010 x 30 x 50 mm



**REC**

•Tapas laterales y frontal incluidas

Ref.	Acabado	P.V.
REC-01-1M	Blanco	<b>38,00 €</b>
REC-19-1M	Negro	<b>38,00 €</b>
REC-01-2M	Blanco	<b>76,00 €</b>
REC-19-2M	Negro	<b>76,00 €</b>



01: Blanco arenado

19: Negro arenado

\* Para atornillar en pared y techo

**ACCESORIOS SERIE REC MAGNÉTICO**

Ref.	Descripción	Acabado	P.V.
REC-01-L	Conexión "L" horizontal	Blanco	<b>12,00 €</b>
REC-19-L	Conexión "L" horizontal	Negro	<b>12,00 €</b>
REC-01-P	Conexión "P" vertical (pared, techo)	Blanco	<b>12,00 €</b>
REC-19-P	Conexión "P" vertical (pared, techo)	Negro	<b>12,00 €</b>

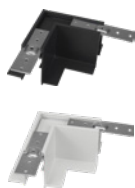

Conexión L

Connexion P

1m: 1000 x 64,3 x 53,7 mm  
Corte: 1010 x 30 x 50 mm

2m: 2000 x 64,3 x 53,7 mm  
Corte: 2010 x 30 x 50 mm



**RIC**

•Tapas laterales y frontal incluidas

Ref.	Acabado	P.V.
RIC-01-1M	Blanco	<b>40,00 €</b>
RIC-19-1M	Negro	<b>40,00 €</b>
RIC-01-2M	Blanco	<b>76,00 €</b>
RIC-19-2M	Negro	<b>76,00 €</b>



01: Blanco arenado

19: Negro arenado

\* Para instalar sobre placas de pladur

**ACCESORIOS SERIE REC MAGNÉTICO**

Ref.	Descripción	Acabado	P.V.
RIC-01-L	Conexión "L" horizontal	Blanco	<b>12,00 €</b>
RIC-19-L	Conexión "L" horizontal	Negro	<b>12,00 €</b>
RIC-01-P	Conexión "P" vertical (pared, techo)	Blanco	<b>12,00 €</b>
RIC-19-P	Conexión "P" vertical (pared, techo)	Negro	<b>12,00 €</b>



Conexión L

Conexión P

01: Blanco

19: Negro

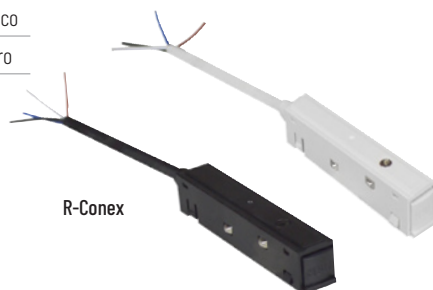

R-Conex

### CONECTORES "R"

Ref.	Acabado	P.V.
R-CONEX-01	Blanco	7,74 €
R-CONEX-19	Negro	7,74 €

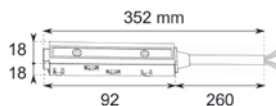

01: Blanco

19: Negro



R-Union

### UNIONES "R"

Ref.	Acabado	P.V.
R-UNION-01	Blanco	7,74 €
R-UNION-19	Negro	7,74 €

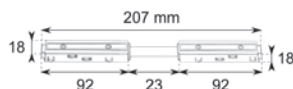

01: Blanco

19: Negro



R-Union-S

### UNIONES-S

Ref.	Acabado	P.V.
R-UNION-S-01	Blanco	7,74 €
R-UNION-S-19	Negro	7,74 €

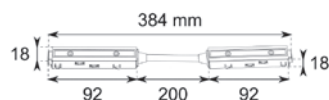

### TIRANTE ACERO

Ref.	P.V.
TIRANTE ACERO	6,30 €
PLETINA TIRANTE ACERO carril magnético	3,00 €

OPCIONES **WiFi** **E**



**MAGNÉTICO**

**48V**

**IP 20**

□ 01: Blanco

■ 19: Negro



### RUNION 360°

Ref.	Acabado	P.V.
RUNION-360°-01/2	Blanco	20,06 €
RUNION-360°-19/2	Negro	20,06 €
RUNION-360°-01/3	Blanco	24,36 €
RUNION-360°-19/3	Negro	24,36 €
RUNION-360°-01/4	Blanco	28,66 €
RUNION-360°-19/4	Negro	28,66 €
RUNION-360°-01/5	Blanco	32,96 €
RUNION-360°-19/5	Negro	32,96 €
RUNION-360°-01/6	Blanco	37,26 €
RUNION-360°-19/6	Negro	37,26 €

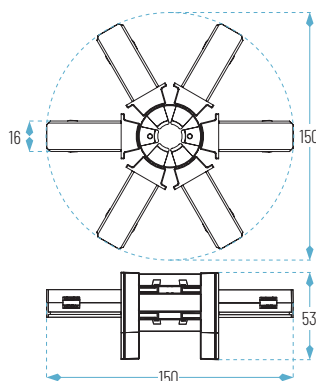



275 x 22 x H44 mm

□ 01: Blanco

■ 19: Negro

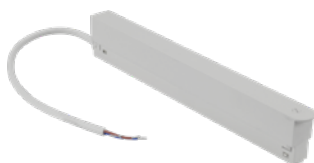

100W-INT-01



250W-INT-19

### DRIVER INTERNO

Ref.	Acabado	Potencia	P.V.
DRIVER-RAC-REC-100W-INT-01	Blanco	100 W	59,00 €
DRIVER-RAC-REC-100W-INT-19	Negro	100 W	59,00 €
DRIVER-RAC-REC-250W-INT-01	Blanco	250 W	79,00 €
DRIVER-RAC-REC-250W-INT-19	Negro	250 W	79,00 €

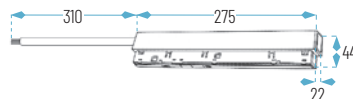

### DRIVER EXTERNO

Ref.	Potencia	P.V.
DRIVER-RAC-REC-100W-EXT	100 W	59,00 €
DRIVER-RAC-REC-150W-EXT	150 W	85,00 €
DRIVER-RAC-REC-350W-EXT	350 W	240,00 €
DRIVER-RAC-REC-500W-EXT	500 W	370,00 €



Conector R necesario para conexión con driver externo. Ver en página 342

### REGULACIÓN EXTERNA DISPONIBLE



Consulte opciones disponibles en apartado de Electrónica