

04. Sistemas Lineales - CARRIL MAGNÉTICO SLIM

ÍNDICE VISUAL

 <p>M1-9W, 18W Pg. 347</p>	 <p>M2-6W Pg. 348</p>	 <p>M3-6W Pg. 349</p>	 <p>M3C-6W Pg. 350</p>	 <p>M4-3W Pg. 351</p>
 <p>M4-6W Pg. 351</p>	 <p>M4-12W Pg. 351</p>	 <p>M6-9W Pg. 352</p>	 <p>M6-18W Pg. 352</p>	 <p>M7-18W Pg. 353</p>
 <p>M8-10W, 20W, 30W Pg. 354</p>	 <p>M9-6W-19 Pg. 355</p>	 <p>M5E-1M/2M Pg. 356</p>	 <p>M5E-19-L Pg. 356</p>	 <p>M5E-19-P Pg. 356</p>
 <p>M5S-1M/2M Pg. 357</p>	 <p>M5S-19-L Pg. 358</p>	 <p>M5S-19-P Pg. 358</p>	 <p>M5 KIT SUSP Pg. 358</p>	 <p>M5 PLETINA Pg. 358</p>
 <p>M5EC-19-R300/R600 Pg. 359</p>	 <p>M5SC-19-R300/R600 Pg. 359</p>	 <p>M-CONEX-19 Pg. 359</p>	 <p>M-UNION-S-19 Pg. 359</p>	 <p>CN-IP40: 50/75/100/150 W Pg. 360</p>
 <p>MD100W-24V Pg. 360</p>	 <p>MD150W-24V Pg. 360</p>	 <p>CN-IP67: 60/100/150 W Pg. 361</p>	 <p>CN-IP67: 240/320 W Pg. 361</p>	

OPCIONES **WiFi** **E**

9W: 300 x 5 x 14 mm
18W: 600 x 5 x 14 mm

MAGNÉTICO **5mm** **24V** **CE** **RoHS** **IP 20** **CRI >90**

M1, 9W, 18W

■ 19: Negro

● 2700K

● Neutro

Ref.	T. ^a Color	Lm	Acabado	P.V.
M1-9W-19-2700K	2700 K	845	Negro	23,04 €
M1-9W-19-4K	4000 K	910	Negro	23,04 €
M1-18W-19-2700K	2700 K	1880	Negro	38,86 €
M1-18W-19-4K	4000 K	1907	Negro	38,86 €



ESFERA DOBLE CRISTAL



Ø80x85 mm



■ 19: Negro

● 2700K

● Neutro



M2-6W-19

M2-6W

Ref.	T. ^a Color	Lm	Acabado	P.V.
M2-6W-19-2700K	2700 K	526	Negro	51,03 €
M2-6W-19-4K	4000 K	548	Negro	51,03 €

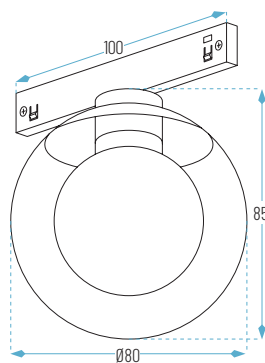

OPCIONES **WiFi** **E**

∅150x150 mm

MAGNÉTICO

5mm

24V

CE

RoHS

IP 20

CRI >90

M3-6W

Ref.	T. ^a Color	Lm	Acabado	P.V.
M3-6W-19-2700K	2700 K	551	Negro	73,16 €
M3-6W-19-4K	4000 K	598	Negro	73,16 €

■ 19: Negro

● 2700K

● Neutro



M3-6W-19

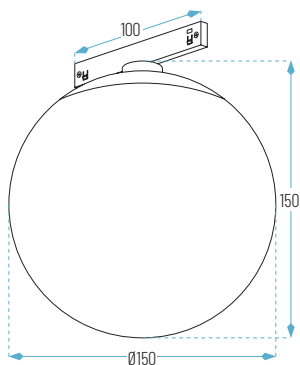

SUSPENSIÓN ESFERA LUNA



Ø150x150 mm



■ 19: Negro

● 2700K

● Neutro



M3C-6W-19

M3C-6W

Ref.	T. ^a Color	Lm	Acabado	P.V.
M3C-6W-19-2700K	2700 K	551	Lunar	71,68 €
M3C-6W-19-4K	4000 K	598	Lunar	71,68 €

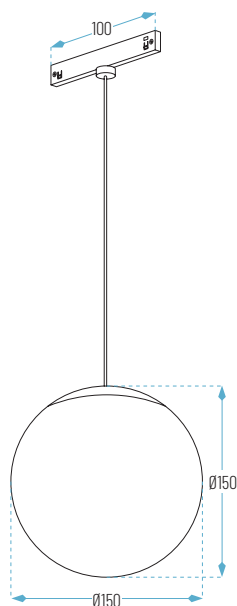

OPCIONES **WiFi** **E**

3W: Ø20 x 60 mm
6W: Ø33 x 85 mm
12W: Ø43 x 110 mm

MAGNÉTICO **5mm**  **24V** **CE**  **IP 20** **CRI >90**

M4 3W, 6W, 12W

Ref.	T.ª Color	Lm	Acabado	P.V.
M4-3W-19-2700K	2700 K	290	Negro	32,84 €
M4-3W-19-4K	4000 K	305	Negro	32,84 €
M4-6W-19-2700K	2700 K	526	Negro	37,66 €
M4-6W-19-4K	4000 K	548	Negro	37,66 €
M4-12W-19-2700K	2700 K	1185	Negro	44,94 €
M4-12W-19-4K	4000 K	1227	Negro	44,94 €

■ 19: Negro

● 2700K

● Neutro

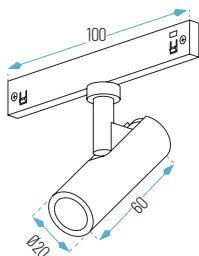

M4-3W-19

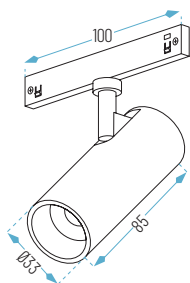

M4-6W-19

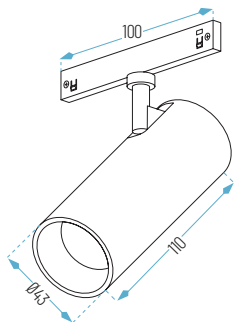

M4-12W-19

FOCO SUPERFICIE REJILLA



9W: Ø95 x 30 mm
18W: Ø168 x 35 mm



■ 19: Negro

● 2700K

● Neutro



M6-9W-19

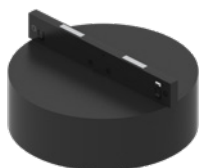

M6-18W-19



M6-9W o 18W

Ref.	T. ^a Color	Lm	Acabado	P.V.
M6-9W-19-2700K	2700 K	880	Negro	44,94 €
M6-9W-19-4K	4000 K	859	Negro	44,94 €
M6-18W-19-2700K	2700 K	1873	Negro	70,92 €
M6-18W-19-4K	4000 K	1866	Negro	70,92 €

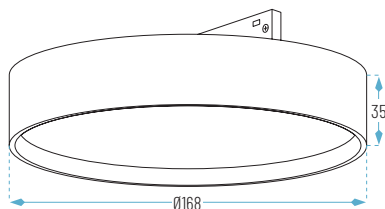
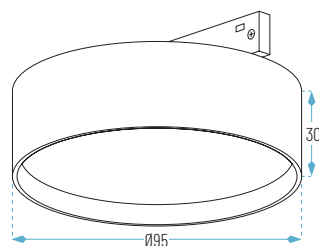

OPCIONES **WiFi** **E**

Ø168 x 20 mm

MAGNÉTICO

5mm

24V

CE

RoHS

IP 20

CRI >90

M7 9W

Ref.	T.ª Color	Lm	Acabado	P.V.
M7-9W-19-2700K	2700 K	893	Negro	58,24 €
M7-9W-19-4K	4000 K	875	Negro	58,24 €

■ 19: Negro

● 2700K

● Neutro

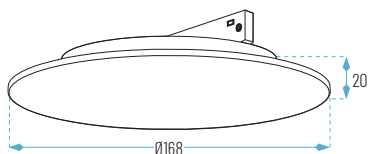

M7-9W

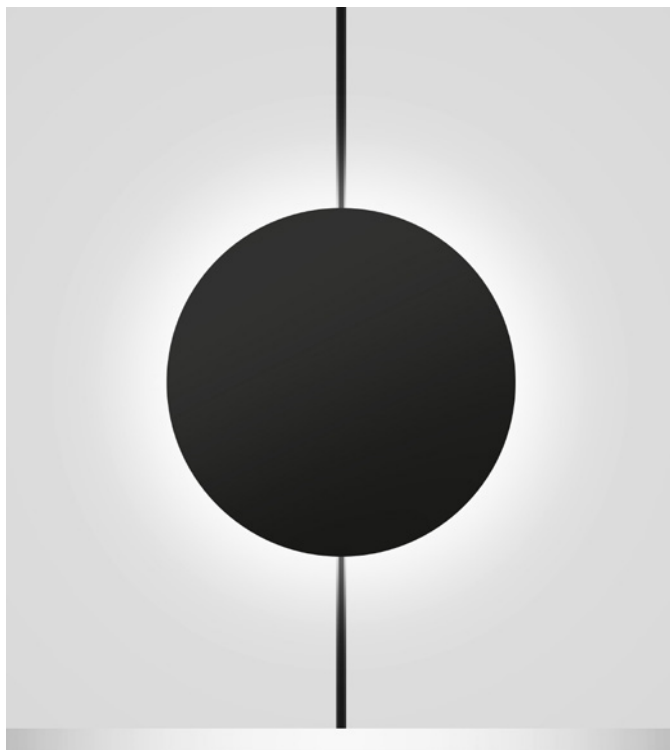

MÓDULO LED LINEAL FLEXIBLE



10W: 1160 mm
20W: 2160 mm
30W: 3160 mm



■ 19: Negro

● 2700K

● Neutro



M8 10W, 20W, 30W

Ref.	T.ª Color	Lm	Acabado	P.V.
M8-10W-19-2700K	2700 K	971	Negro	36,05 €
M8-10W-19-4K	4000 K	990	Negro	36,05 €
M8-20W-19-2700K	2700 K	2086	Negro	49,92 €
M8-20W-19-4K	4000 K	2086	Negro	49,92 €
M8-30W-19-2700K	2700 K	3252	Negro	63,70 €
M8-30W-19-4K	4000 K	3268	Negro	63,70 €

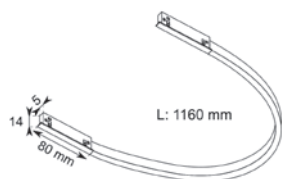
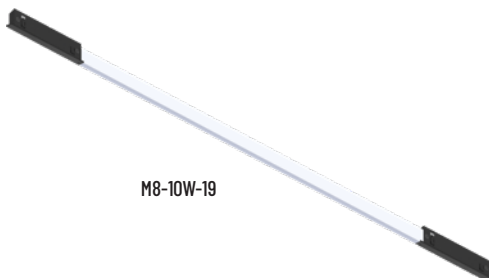
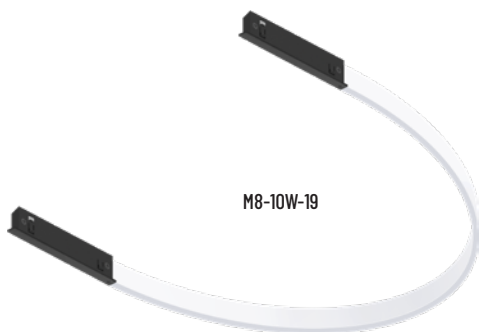

M8-10W

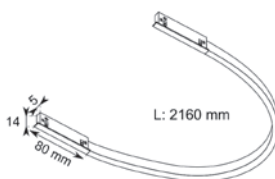

M8-20W

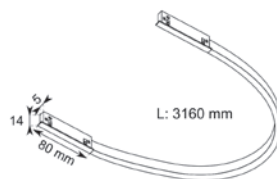

M8-30W

OPCIONES **WiFi** **E**

Ø30 x 300 mm

MAGNÉTICO **5mm** **24V** **CE** **RoHS** **IP 20** **CRI >90**

M9 6W

Ref.	T.ª Color	Lm	Acabado	P.V.
M9-6W-19-2700K	2700 K	526	Negro	48,58 €
M9-6W-19-4K	4000 K	548	Negro	48,58 €

■ 19: Negro

● 2700K

● Neutro



M9-19

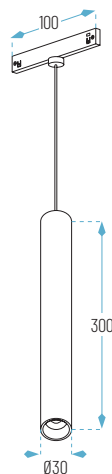

CARRIL EMPOTRADO



1m: 1000×38×19 mm
2m: 2000×38×19 mm



■ 19: Negro



M5E-19

M5E

Ref.	Acabado	P.V.
M5E-19-1M	Negro	17,50 €
M5E-19-2M	Negro	35,00 €

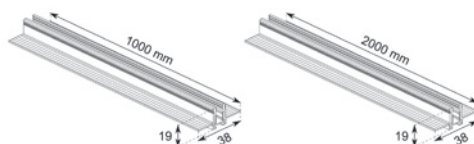

■ 19: Negro

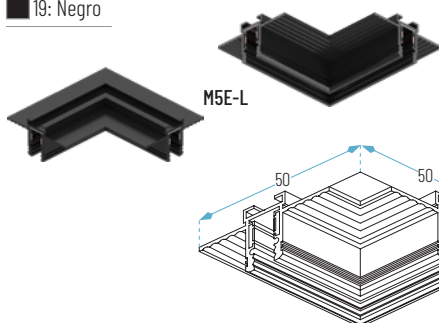

M5E-L

M5E-L

Unión para Esquina 90° - Horizontal

Ref.	Medidas	Acabado	P.V.
M5E-19-L	50 x 50 x 19 mm	Negro	9,80 €



■ 19: Negro

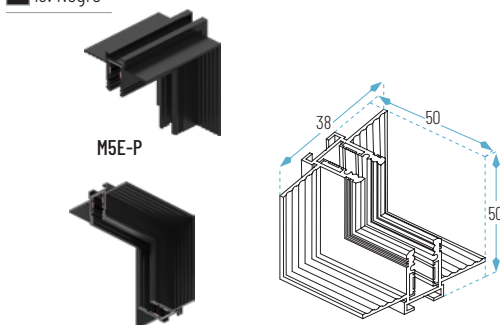

M5E-P

M5E-P

Unión para Esquina 90° - Vertical

Ref.	Medidas	Acabado	P.V.
M5E-19-P	50 x 50 x 38 mm	Negro	9,80 €

OPCIONES **WiFi** **E**

1m: 1000×10,8×19 mm
2m: 2000×10,8×19 mm

MAGNÉTICO **5mm** **24V** **CE** **RoHS** **IP 20** **CRI >90**

■ 19: Negro

M5S

Ref.	Acabado	P.V.
M5S-19-1M	Negro	15,34 €
M5S-19-2M	Negro	30,66 €



M5S

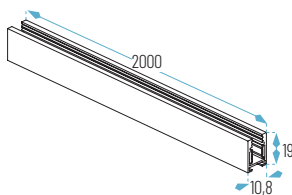
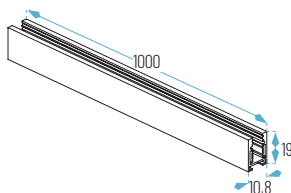

CARRIL EMPOTRADO



19: Negro



M5S-L

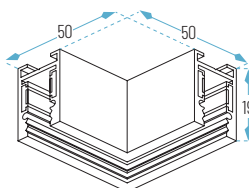

M5S-L

Unión para Esquina 90° - Horizontal

Ref.	Medidas	P.V.
M5S-19-L	50 x 50 x 19 mm	7,00 €



19: Negro



M5S-P

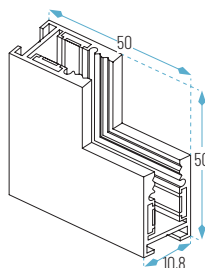

M5S-P

Unión para Esquina 90° - Vertical

Ref.	Medidas	P.V.
M5S-19-P	50 x 50 x 10,7 mm	7,00 €



M5 KIT SUSP

Sistema de Suspensión para Carril

Ref.	P.V.
M5-KIT SUSP	4,7 €



M5 PLETINA

Uniones para Carril

Ref.	Medidas	P.V.
M5 Pletina	80 x 8 x 1,2 mm	0,98 €

OPCIONES **WiFi** **E**

R300: 400 × 400 × 19 mm
R600: 700 × 700 × 19 mm

MAGNÉTICO **5mm** **24V** **CE** **RoHS** **IP 20**

M5EC

Carril Curvo Empotrado

■ 19: Negro

Ref.	Acabado	P.V.
M5EC-19-R300	Negro	48,79 €
M5EC-19-R600	Negro	59,71 €



M5EC

M5SC

Carril Curvo para superficie

Ref.	Acabado	P.V.
M5SC-19-R300	Negro	46,55 €
M5SC-19-R600	Negro	57,47 €

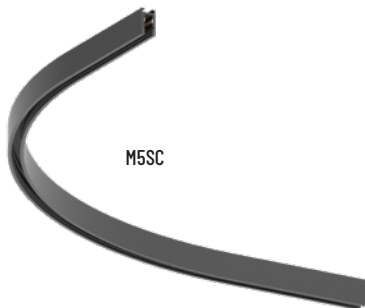
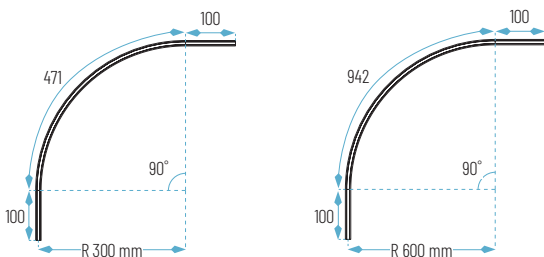

M5SC

OPCIONES **WiFi** **E**

MAGNÉTICO **24V** **CE** **RoHS** **IP 20**

M-CONEX

Módulo de conexión

Ref.	Acabado	P.V.
M-CONEX-19	Negro	5,90 €

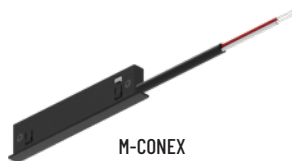

M-CONEX

M-UNION-S

Conector Flexible entre Carriles

Ref.	Acabado	P.V.
M-UNION-S-19	Negro	9,10 €



M-UNION-S

FUENTES ALIMENTACIÓN TENSIÓN CONSTANTE



CN-50W-24V-IP40



CN-100W-24V-IP40



CN-150W-24V-IP40

CN-50W, CN-100W, CN-150W (24V-IP40)

- Diseño para uso Independiente Ultra Compacto
- Tensión Constante 24 VDC.
- PFC, EMC,
- Sin Parpadeo.
- Tensión de entrada 176-280VAC.
- Protecciones: Cortocircuito, Sobrecarga, Sobretemperatura.
- Sobretensión integrado 2kV.
- Clase II

Ref.	P.V.
CN-50W-24V-IP40	20,40 €
CN-75W-24V-IP40	27,60 €
CN-100W-24V-IP40	34,00 €
CN-150W-24V-IP40	43,60 €

FUENTE DE ALIMENTACIÓN INTEGRADA



Ø85x30 mm

OPCIONES **WiFi** **E**

■ 19: Negro



MD100W



MD150W

MD 100W, 150W

Ref.	Potencia	Acabado	P.V.
MD100W-24V	100W	Negro	63,70 €
MD150W-24V	150W	Negro	76,52 €

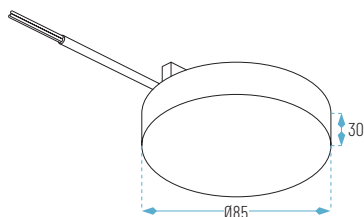

Consulte más opciones disponibles en apartado de Electrónica



CN-60W, CN-100W, CN-150W (24V-IP67)

- Diseño para uso Independiente IP67
- Tensión Constante 24 VDC.
- PFC, EMC,
- Sin Parpadeo.
- Tensión de entrada 200-264VAC.
- Con Manguera en Entrada y Salida Tensión.
- Protecciones: Cortocircuito, Sobrecarga, Sobretemperatura.
- Sobretensión integrado 2kV.
- Clase II
- IP67



Ref.	P.V.
CN-60W-24V-IP67	31,40 €
CN-100W-24V-IP67	40,80 €
CN-150W-24V-IP67	50,80 €



CN-240W, CN-320W (24V-IP67)

- Diseño para uso Independiente IP67
- Caja Metálica
- Tensión Constante 24 VDC.
- PFC, EMC,
- Sin Parpadeo.
- Tensión de entrada 90-264VAC.
- Con Manguera en Entrada y Salida Tensión.
- Protecciones: Cortocircuito, Sobrecarga, Sobretemperatura.
- Sobretensión integrado 6kV.
- Clase I
- IP67

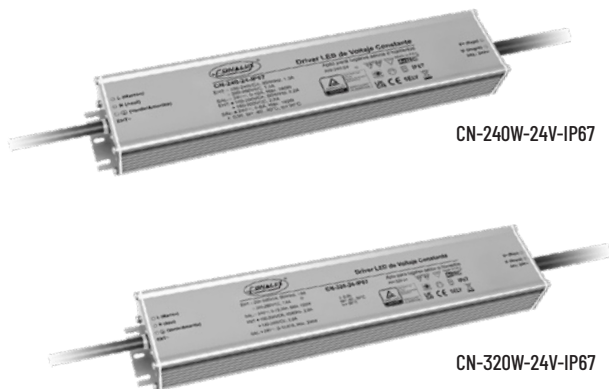

Ref.	P.V.
CN-240W-24V-IP67	73,20 €
CN-320W-24V-IP67	99,20 €

Consulte más opciones disponibles en apartado de Electrónica

