



06. INDUSTRIAL

ÍNDICE VISUAL

 <p>TUBULAR 120 / 150 Pg. 534</p>	 <p>PANTALLA ESTANCA VACÍA EV118 Pg. 536</p>	 <p>PANTALLA ESTANCA VACÍA EV136 Pg. 536</p>	 <p>PANTALLA ESTANCA VACÍA EV158 Pg. 536</p>	 <p>PANTALLA ESTANCA VACÍA EV218 Pg. 536</p>
 <p>PANTALLA ESTANCA VACÍA EV236 Pg. 536</p>	 <p>PANTALLA ESTANCA VACÍA EV258 Pg. 536</p>	 <p>T8 LED SMD 9W, 22W Pg. 536</p>	 <p>T8 LED SMD-RADAR ON-OFF 10W, 18W, 22W Pg. 537</p>	 <p>T8 LED SMD RADAR 10W, 18W, 22W Pg. 537</p>
 <p>CROATIA 6009-18W Pg. 539</p>	 <p>CROATIA 6009-36W Pg. 539</p>	 <p>CROATIA 6009-48W Pg. 539</p>	 <p>P-ATEXG100W5K Pg. 540</p>	 <p>P6002N-50W-S Pg. 541</p>
 <p>P6002-10W, 30W, 50W, 100W Pg. 542</p>	 <p>P6002N-100W, 150W, 200W Pg. 543</p>	 <p>P6001-30W, 50W Pg. 544</p>	 <p>P6001-100W, 150W, 200W Pg. 547</p>	 <p>P7015-400W Pg. 548</p>
 <p>P7015-600W Pg. 549</p>	 <p>P9100-40W Pg. 550</p>	 <p>UFO 150W-EM Pg. 551</p>	 <p>UFO23 150W /200W Pg. 551</p>	 <p>UFO43 100W, 150W, 200W Pg. 552</p>

 <p>UFO COMPACT-150W Pg. 553</p>	 <p>CL5260-80-120-160W Pg. 555</p>	 <p>CL5260-200W Pg. 556</p>	 <p>V5700 100-120-150W Pg. 558</p>	 <p>V5700 50-60-70-80W Pg. 559</p>
 <p>V5900 50W Pg. 560</p>	 <p>V5900 70W Pg. 560</p>	 <p>V5900 100W Pg. 560</p>	 <p>V5900 150W Pg. 560</p>	 <p>V5900 200W Pg. 560</p>
 <p>F5600 VILLA LED Pg. 561</p>	 <p>F5800 SEMIGLOBO LED Pg. 562</p>	 <p>ACCESORIOS FAROLAS Pg. 563</p>	 <p>ACOPLES FAROLAS Pg. 564</p>	

TUBULAR ESTANCA COLGANTE / SUPERFICIE LED



Tubular 120-4K 85 x 85 x 1200 mm
Tubular 150-4K 85 x 85 x 1500 mm

OPCIONES **WiFi** **E**

B: Blanco

Neutro

**TUBULAR**

Estanca colgante / superficie LED enlazable
Longitud cable 1 m

Lúmenes aplicación:
TUBULAR120-4K: 4000 lm
TUBULAR150-4K: 5000 lm

Ref.	Acabado	W	P.V.
TUBULAR120-4K	Blanco mate	40 W	79,92 €
TUBULAR150-4K	Blanco mate	65 W	104,78 €





PANTALLAS ESTANCAS

PANTALLA ESTANCA VACÍA
PARA TUBOS LED

Ref.	Descripción	Materiales	P.V.
1 TUBO			
EV118	1x18 660x64x80 mm	ABS+PC	13,30 €
EV136	1x36 1260x64x80 mm	ABS+PC	18,40 €
EV158	1x58 1560x64x80 mm	ABS+PC	24,60 €
2 TUBOS			
EV218	2x18 660x96x80 mm	ABS+PC	15,40 €
EV236	2x36 1260x96x80 mm	ABS+PC	22,70 €
EV258	2x58 1560x96x80 mm	ABS+PC	29,50 €

Clips acero inoxidable	P.V.
CLIPSMETAL	0,52 €

TUBO LED T8



01: Blanco

Neutro

TUBOS LED
CRISTAL T8

TCX 4150-24W

TCX 460-9W

Esquema Conexión Tubo LED:

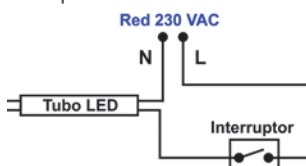

T8 LED SMD

Ref.	Tª Color	Potencia	Longitud	P.V.
TCX 460 9W	4000K	9 W	60 cm	7,14 €
TCX 4150 24W	4000K	24 W	150 cm	14,60 €

Lúmenes chip: 9W: 900 lm; 24W: 2400 lm
Lúmenes aplicación: 9W: 774 lm; 24W: 2064 lm

OPCIONES **E**



TUBO LED
CON SENSOR
RADAR ON/OFF



TSNONFF-6150-22W

01: Blanco

Frío

TSNONFF-6120-18W

TSNONFF-660-10W

T8 LED SMD-RADAR ON-OFF

- Con sensor radar de alta frecuencia
- Tiempo de encendido: 30 segundos
- Funcionamiento ON-OFF: el tubo siempre está apagado hasta que detecta movimiento en su zona y pasa a funcionar al 100%, al cabo de 30 segundos sin movimiento detectado volverá a apagarse

Esquema Conexión
Tubo LED ON/OFF:

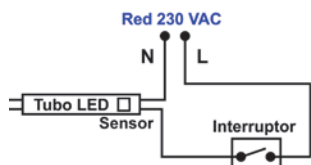

Ref.	Tª Color	Potencia	Longitud	P.V.
TSNONFF-660-10W	6000K	10 W	60 cm	38,85 €
TSNONFF-6120-18W	6000K	18 W	120 cm	43,05 €
TSNONFF-6150-22W	6000K	22 W	150 cm	49,35 €

E



01: Blanco

Frío

TS86150-22W

TS86120-18W

TS8660-10W

TUBO LED CON
SENSOR-RADAR
ALTA FRECUENCIA

Esquema Conexión Tubo LED
con Sensor-Radar:

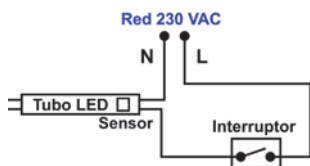



T8 LED SMD RADAR

- Con sensor radar de alta frecuencia
- Doble nivel de luminosidad, 3W en reposo y 100% en modo detección

Ref.	Tª Color	Potencia	Longitud	P.V.
TS8660-10W	6000K	10 W	60 cm	35,70 €
TS86120-18W	6000K	18 W	120 cm	39,90 €
TS86150-22W	6000K	22 W	150 cm	46,20 €





-  Gris
-  Neutro
-  Frío



6009-18W
38 x 600 x H68mm



6009-36W
38 x 1200 x H68mm



6009-48W
38 x 1500 x H68mm



CROATIA 6009

Lúmenes chip:
6009-18W 1800 lm
6009-36W 3600 lm
6009-48W 4800 lm



Ref.	Tª Color	Potencia	P.V.
6009-18W	4000K, 5000K	18 W	33,30 €
6009-36W	4000K, 5000K	36 W	48,50 €
6009-48W	4000K, 5000K	48 W	57,60 €

PROYECTOR ATEX



300 x 300 x 175mm

OPCIONES

■ Gris

● Frío



110°



P-ATEXG100W5K
300 x 300 x 175mm



P-ATEXG100W5K

Lúmenes chip: P-ATEXG100W5K: 15000 lm
Lúmenes aplicación: P-ATEXG100W5K: 11000 lm

Ref.	P.V.
P-ATEXG100W5K	672,00 €

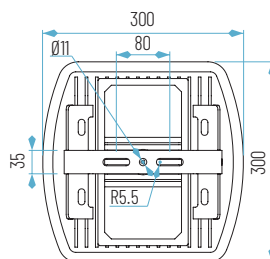
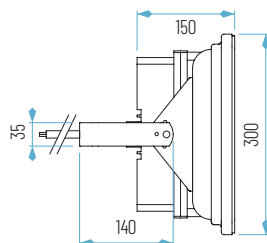
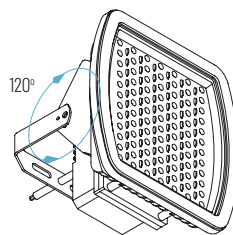

OPCIONES **WiFi**



P6002N-50W-S

■ N: Negro

● Frío

Ref.	P.V.
P6002N-50W-S-5K	55,55 €



P6002N-50W-S

Lúmenes chip:
P6002N-50W-S: 4750 lm
Lúmenes aplicación:
P6002N-50W-S: 4000 lm

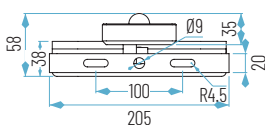
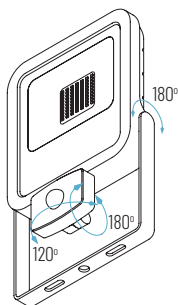
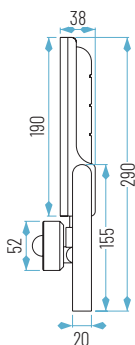
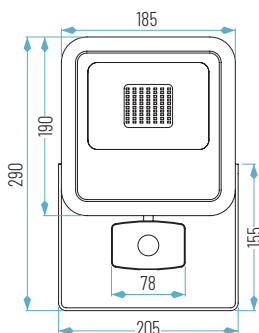

SOPORTE P. PROYECTOR 10W-100W

Ref.	Color	Medidas	P.V.
SOPORTP 700-01 (Blanco) -19 (Negro)		700 mm	38,64 €
SOPORTP 1000-01 (Blanco) -19 (Negro)		1000 mm	41,58 €



PROYECTORES



10W: 101 x 28,5 x 125 mm
30W: 163 x 34 x 186 mm

50W: 201 x 37 x 226 mm
100W: 306 x 70 x 326 mm

OPCIONES **WiFi** **E**

■ 19: Negro

● Cálido

● Frío



P6002-100W

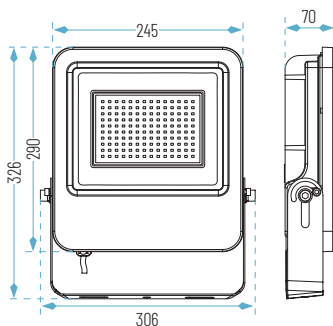

P6002 10W, 30W, 50W Y 100W NO DIMABLE

Ref.	Tª Color	lm	P.V.
P6002-10W-3K	3000K	990 lm	13,55 €
P6002-10W-5K	5000K	1100 lm	13,55 €
P6002-30W-3K	3000K	2700 lm	26,75 €
P6002-30W-5K	5000K	3300 lm	26,75 €
P6002-50W-3K	3000K	4750 lm	39,25 €
P6002-50W-5K	5000K	5500 lm	39,25 €
P6002-100W-5K	5000K	13000 lm	85,89 €
Pincho 6002 metálico			3,30 €



Pincho 6002



P6002-50W



P6002-30W



P6002-10W

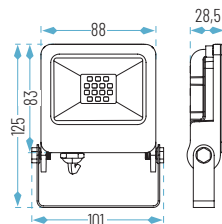
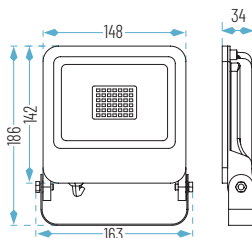
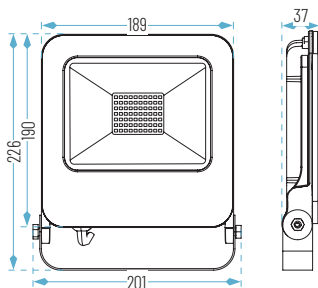

OPCIONES **WiFi** **E**

100W: 306 x 70 x H326 mm
150W: 333 x 51 x H420mm

200W: 385 x 51 x H470mm



SERIE P6002N, 100W, 150W Y 200W

■ N: Negro

● Neutro

● Frio

Ref.	Tª Color	100 W	150 W	200 W
P6002N (Negro)	4000K o 5000K	85,89 €	95,00 €	120,00 €



P6002N-100W

Lúmenes chip:
P6002N-100W: 14480 lm
Lúmenes aplicación:
P6002N-100W: 13000 lm



P6002N-150W

Lúmenes chip:
P6002N-150W: 21730 lm
Lúmenes aplicación:
P6002N-150W: 20257 lm



P6002N-200W

Lúmenes chip:
P6002N-200W: 28750 lm
Lúmenes aplicación:
P6002N-200W: 27010 lm

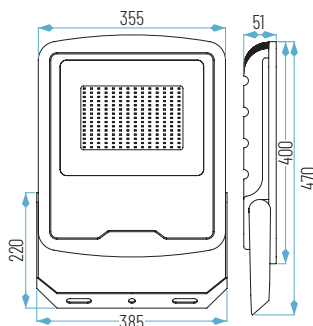
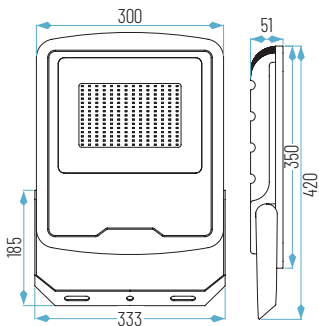
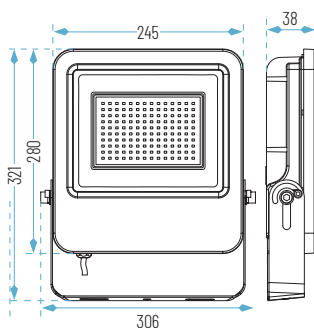

SOPORTE PROYECTOR 150W-200W

Ref.	Color	Medidas	P.V.
SOPORT 700	Negro	700 mm	57,65 €
SOPORT 1000	Negro	1000 mm	60,69 €

PROYECTORES LED



30W: 169 x 51 x 242 mm
50W: 220 x 52 x 283 mm

OPCIONES **WiFi** **REG** **E**

■ N: Negro

● Cálido

● Neutro

Principal



Opciones



P6001 30W

REGULABLE 1-10V

Lúmenes chip: P6001-30W: 4050 lm
Lúmenes aplicación: P6001-30W: 3600 lm

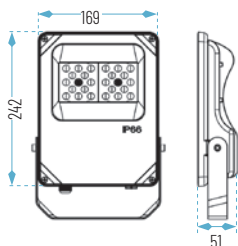

P6001 50W

REGULABLE 1-10V

Lúmenes chip: P6001-50W: 6750 lm
Lúmenes aplicación: P6001-50W: 6000 lm

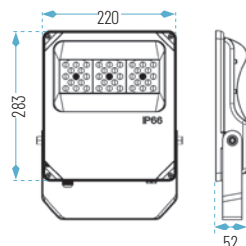

SERIE P6001 30W Y 50W

Ref.	Tª Color	P.V.
P6001-30W	3000K y 4000K	84,20 €
P6001-50W	3000K y 4000K	91,00 €





OPCIONES



100W - 150W: 376,5 x 62,25 x 402,42 mm
200W: 376,5 x 62,25 x 464,42 mm



P6001 100W, 150W Y 200W

Ref.	Tª Color	P.V.
P6001-100W	3000K o 4700K	209,50 €
P6001-150W	3000K o 4700K	224,50 €
P6001-200W	3000K o 4700K	249,50 €

Lúmenes chip:
P6001-100W: 17000 lm
P6001-150W: 25000 lm
P6001-200W: 35000 lm

Lúmenes aplicación:
P6001-100W: 14000 lm
P6001-150W: 21000 lm
P6001-200W: 28000 lm



P6001-150W

REGULABLE 1-10V

■ N: Negro

● Cálido

● Neutro

Principal



Opciones

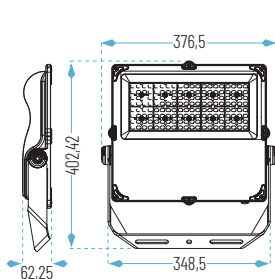

100W-150W

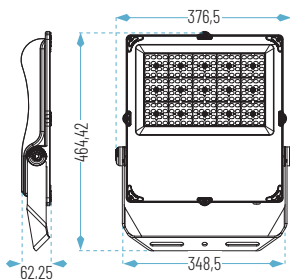

200W

RESULTADOS FOTOMÉTRICOS para la referencia P6001

ASI 2

ASI 3

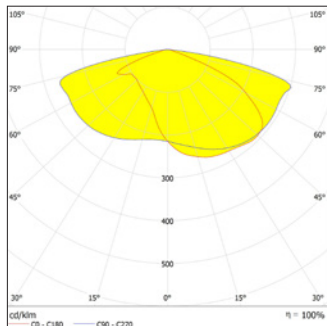
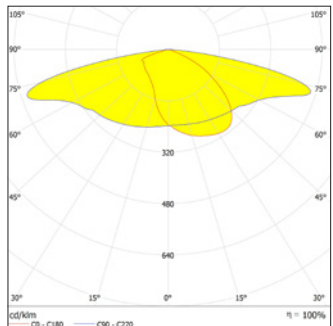

P6001-150W

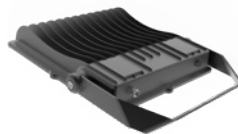

P6001-200W



■ G: Gris

● Frío

Principal



Opciones

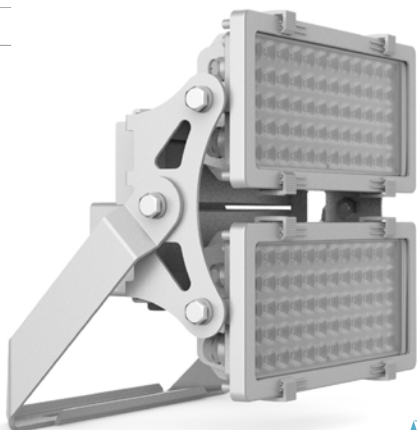

P7015-400W

REGULABLE 1-10V

P7015 400W

Lúmenes chip: P7015 400W: 54000 lm
Lúmenes aplicación: P7015 400W: 46800 lm

Ref.	P.V.
P7015 400W 5000K	743,00 €

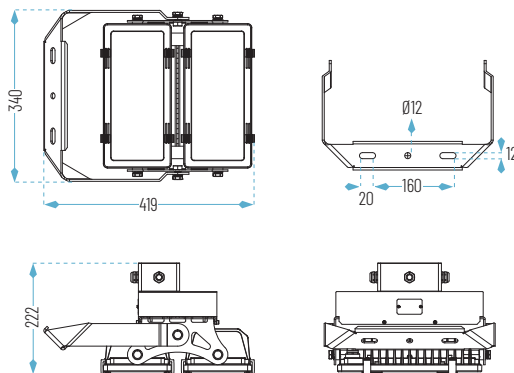

RESULTADOS FOTOMÉTRICOS

para la referencia P7015-400 30°

para la referencia P7015-400 45°

para la referencia P7015-400 60°

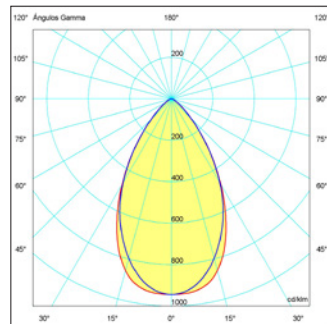
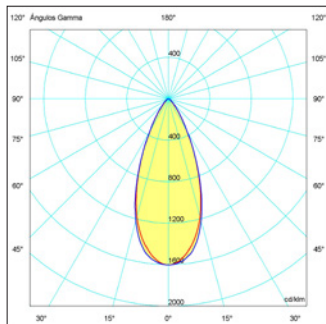
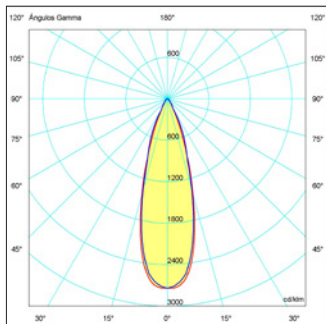

OPCIONES **WiFi** **REG** **E**

REG. 1-10 V Flicker Free CE RoHS >135 lm/W **IK 08** **IP 65** **FP >0.9** **CRI >80**

P7015 600W

Lúmenes chip: P7015 600W: 81000 lm
Lúmenes aplicación: P7015 600W: 72000 lm

Ref. P7015 600W 5000K P.V. 1028,00 €

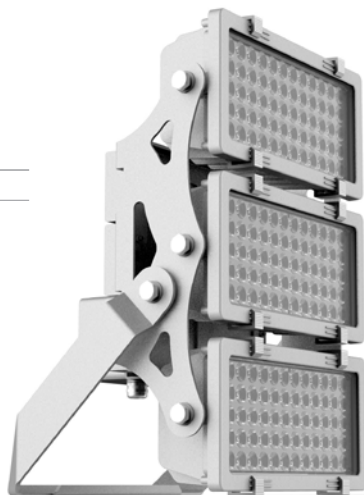

G: Gris

Frío

Principal



Opciones

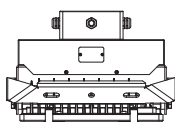
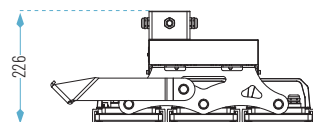
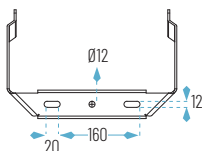
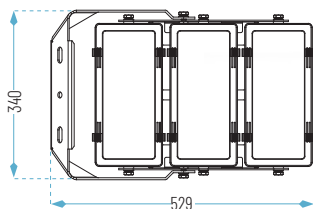

P7015-600W

REGULABLE 1-10V

RESULTADOS FOTOMÉTRICOS

para la referencia P7015-600 30°

para la referencia P7015-600 45°

para la referencia P7015-600 60°

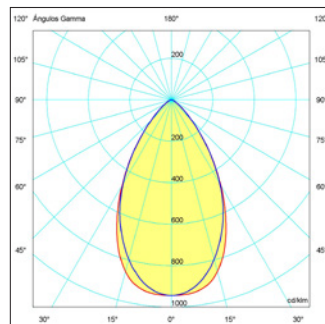
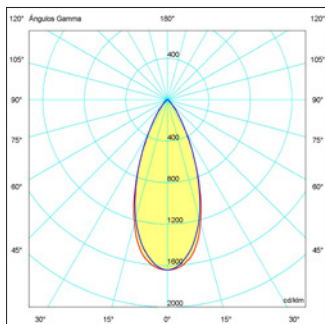
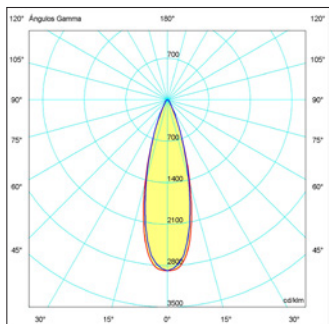



200 x 120 x 810 mm



B: Blanco

N: Negro

Cálido

Neutro



P9100 Blanco



P9100 Negro



P9100 40W

Lúmenes chip: P9100-40W: 4800 lm
Lúmenes aplicación: P9100-40W: 3200 lm

Ref.	Blanco	Negro
P9100-40W 3000K o 4000K	135,03 €	135,03 €
Soporte incluido en el precio		

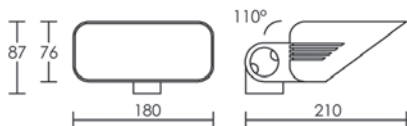
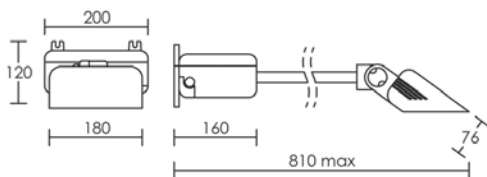

RESULTADOS FOTOMÉTRICOS
para la referencia P9100 40W

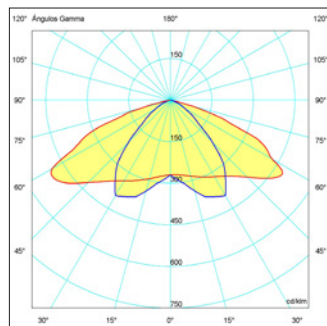

OPCIONES **REG** UFO-150W-EM5K: Ø270 × 270 mm **REG. 1-10 V** **NICHIA** **MW MEAN WELL** **FF** **CB** **CE** **RoHS** **>124 lm/W** **IP 65** **FP >0.95** **CRI >80**

UFO 150W-EM

• Con alumbrado de continuidad 90 minutos a 20W

UFO 150W CON ALUMBRADO DE CONTINUIDAD	P.V.
UFO 150W-EM 5000K	514,50 €



UFO-150W-EM

■ N: Negro

● Frío



REGULABLE 1-10V

CON ALUMBRADO DE CONTINUIDAD

OPCIONES **Wi Fi** UFO23: Ø292 × 65 mm **CREE LEDs** **CE** **RoHS** **IK 07** **IP 65** **FP >0.95** **CRI >80**

UFO23 150W Y 200W

Ref.	Tª Color	Acabado	P.V.
UFO23-150W	4000K o 5000K	Negro	129,15 €
UFO23-200W	4000K o 5000K	Negro	156,45 €

■ 19: Negro

● Neutro

● Frío

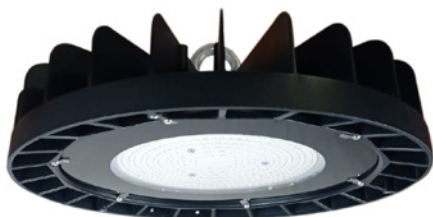

UFO23-150W

Lúmenes chip: UFO23-150W: 16500 lm
Lúmenes aplicación: UFO23-150W: 14250 lm

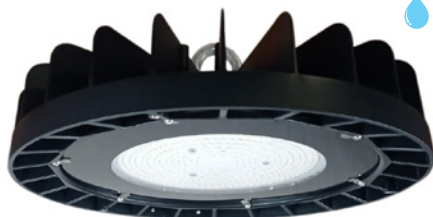

UFO23-200W

Lúmenes chip: UFO23-200W: 19800 lm
Lúmenes aplicación: UFO23-200W: 19000 lm

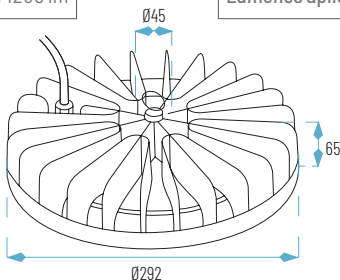

CAMPANAS LED

CRI >90 **FP >0,95** **IP 65** **IK 08** **145 lm/W** **RoHS** **CE** **CB** **Flicker Free** **PHILIPS LUMILEDS** **REG. 1-10 V** **OPCIONES** **WiFi** **REG**

■ 19: Negro

REGULABLE 1-10V

● Neutro

5 AÑOS DE GARANTÍA

● Frío



UF043-100W

Lúmenes chip: 14450 lm
Lúmenes aplicación: 13558 lm

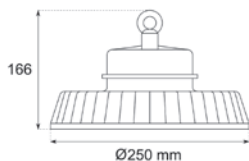

UF043-150W

Lúmenes chip: 21700 lm
Lúmenes aplicación: 20098 lm

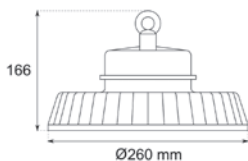

UF043-200W

Lúmenes chip: 29000 lm
Lúmenes aplicación: 27332 lm

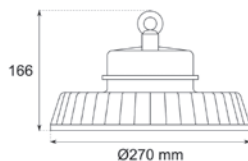

Sin difusor



Con difusor



Disponemos de Lentes 90° para los 3 modelos de UFOS



UF043 100W, 150W Y 200W

P.V. UF043	100 W	150 W	200 W
UF043	145,00 €	182,90 €	194,50 €
DIFUSORUF043 60°- 90°	23,10 €	23,10 €	23,10 €
LIRAUF043	24,00 €	24,00 €	24,00 €

Opción conector para dimmado, ver en apartado 10. Electrónica

OPCIONES **WiFi** **E**

Ø398 x 211 mm



B: Blanco

Frío



UFO COMPACT-150W

UFO COMPACT-150W

Ref.	Tª Color	Potencia	P.V.
UFO COMPACT	5000K	150 W	184,00 €

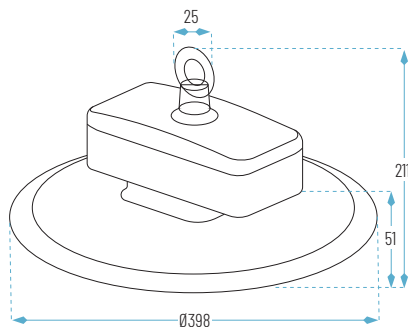



UFO con Reflector de Aluminio
Para UFO 100W, 200W y 150W-EM

DIFUSOR DE ALUMINIO

Ref.	P.V.
DIFUSORUF090°	23,10 €



UFO con Reflector de Policarbonato
Para UFO 150W-EM

DIFUSOR DE POLICARBONATO

Ref.	P.V.
DIFUSORUFO-PC	33,60 €



Lira UFO
Para UFO 100W, 200W y 150W-EM

LIRA UFO

Ref.	P.V.
LIRAUFO	25,20 €

OPCIONES **WiFi** **REG**

REG. 1-10 V

PHILIPS LUMILEDS

MW MEAN WELL

Flicker Free

CE

RoHS

140 lm/W

IP 65

FP >0.9

CRI >80

CL5260

• Lente PC

Principal



60x90°

Opciones



30x70°



120°

■ N: Negro

● Cálido

● Neutro

● Frío



REGULABLE 1-10V



Lúmenes chip: CL5260-80W: 11200 lm
Lúmenes aplicación: CL5260-80W: 10388 lm

CL5260 80W

P.V.

CL5260-80W 3000K, 4000K o 5000K

220,35 €

CL5260-80W

490 x 138 x 116mm

REGULABLE 1-10V



Lúmenes chip: CL5260-120W: 16800 lm
Lúmenes aplicación: CL5260-120W: 15250 lm

Ref. **CL5260 120W**

P.V.

CL5260-120W 3000K, 4000K o 5000K

280,15€

CL5260-120W

722 x 138 x 116mm

REGULABLE 1-10V



Lúmenes chip: CL5260-160W: 22400 lm
Lúmenes aplicación: CL5260-160W: 20340 lm

CL5260 160W

P.V.

CL5260-160W 3000K, 4000K o 5000K

344,53 €

CL5260-160W

954 x 138 x 116mm

CAMPANAS LED LINEALES



- N: Negro Principal
- Cálido 
- Neutro Opciones
- Frio 
- 
- 120° 

CL5260

- Lente PC

Lúmenes chip: CL5260-200W: 28000 lm
Lúmenes aplicación: CL5260-200W: 25763 lm

CL5260 200W

P.V.

CL5260-200W 3000K, 4000K o 5000K

351,90 €

REGULABLE 1-10V

CL5260-200W
1186x 138 x 116mm

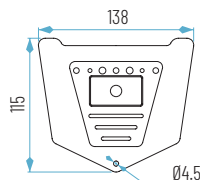

ACCESORIO



Escuadra ESC-CL5260
Escuadras de fijación incluidas

- 80W: 495mm
- 20W: 730mm
- 160W: 955mm
- 200W: 1190mm

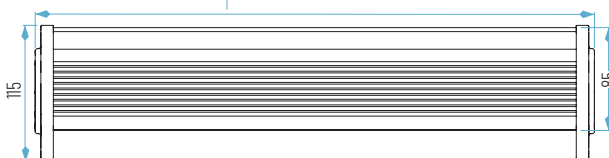

RESULTADOS FOTOMÉTRICOS

para la referencia CL5260 30°x70° para la referencia CL5260 60°x90° para la referencia CL5260 120°

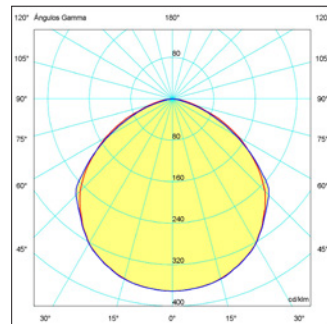
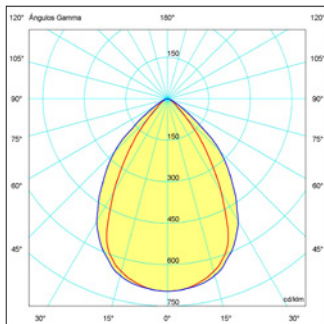
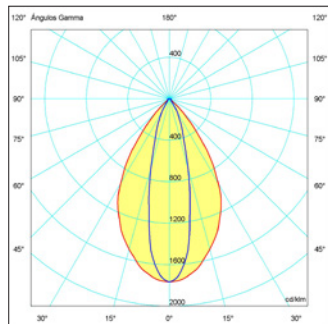



VIAL LED



OPCIONES **WiFi** **REG**

04: Gris

● Cálido

● Neutro

● Frío



REGULABLE 1-10V

RAL 9007

Cabeza:
Ancho x Largo x Alto
320 x 331 x 94 mm

| Ø 65 mm |

V5700

Lúmenes chip:

V5700-100W: 16500 lm

V5700-120W: 19200 lm

V5700-150W: 24000 lm

Lúmenes aplicación:

V5700-100W: 14627,45 lm

V5700-120W: 15638,26 lm

V5700-150W: 20519,97 lm

Ref.	P.V.
V5700-100W 3000K, 4000K o 5000K	273,00 €
V5700-120W 3000K, 4000K o 5000K	294,00 €
V5700-150W 3000K, 4000K o 5000K	313,95 €

Ref. FOTOCÉLULA	P.V.
FTV5700	102,90 €



Fotocélula sensible a la luz

RESULTADOS FOTOMÉTRICOS

para la referencia V5700

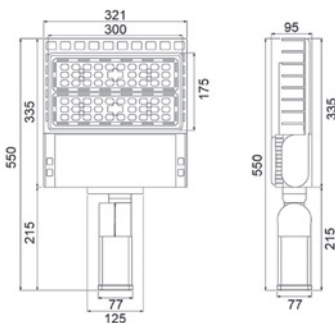
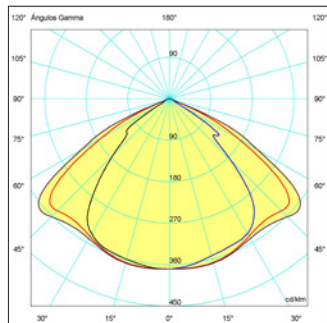



SERIE V5700

Lúmenes chip:
 V5700-50W: 6750 lm
 V5700-60W: 8100 lm
 V5700-70W: 9450 lm
 V5700-80W: 10800 lm

Cabeza:
 Ancho x Largo x Alto
 333,21 x 71 x 311,85 mm

REGULABLE 1-10V

04: Gris

● Neutro

● Frio



Ref.	Tª Color	P.V.
V5700-50W	4000K o 5000K	249,90 €
V5700-60W	4000K o 5000K	252,00 €
V5700-70W	4000K o 5000K	260,40 €
V5700-80W	4000K o 5000K	260,40 €



RAL 9007

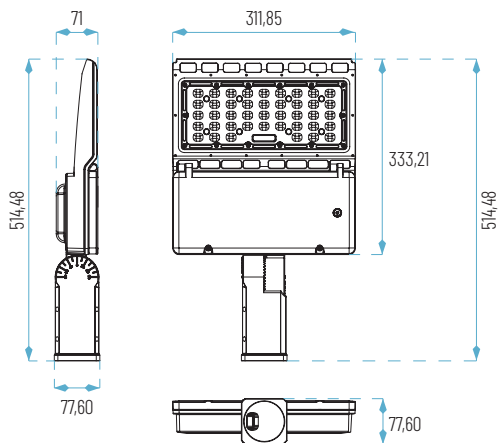

VIAL LED



OPCIONES **WiFi** **E**

■ 04: Gris

● Cálido

● Neutro

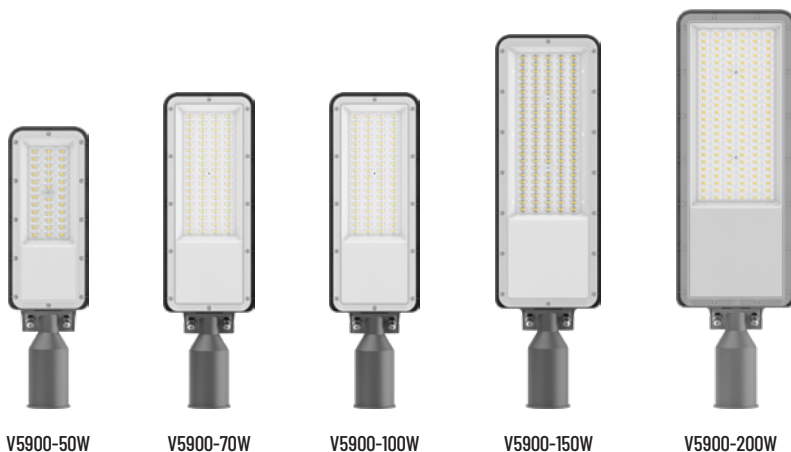

V5900 50W, 70W, 100W, 150W Y 200W

Ref.	Tª Color	lm	P.V.
V5900-50W	3K o 4K	6000 lm	46,02 €
V5900-70W	4K	8400 lm	63,06 €
V5900-100W	3K o 4K	12000 lm	69,35 €
V5900-150W	4K	18000 lm	98,01 €
V5900-200W	4K	24000 lm	119,84 €

Tamaño de pole: 60 mm

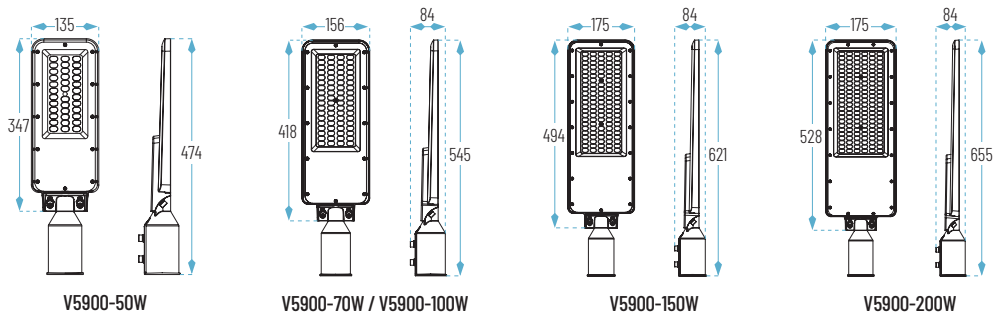
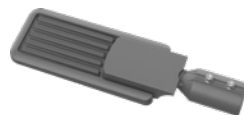

OPCIONES **WiFi** **REG**

400 x 400 x 810 mm

OSRAM

MW
MEAN WELL

Flicker Free

CE

RoHS

IP 67

FP >0.9

CRI >80

F5600 VILLA LED-50W

- Incluye un protector de sobretensiones transitorias
- Opción de sistemas de telegestión
- Consultar opciones de control y dimmado
- Regulable 1/10V

■ N: Negro

● Cálido

● Neutro



Lúmenes chip: F5600-50W: 5600 lm
Lúmenes aplicación: F5600-50W: 4970 lm

Ref.	T.ª Color	Difusor	P.V.
F5600-50W-3K-DT	3K	Transparente	270,00 €
F5600-50W-4K-DT	4K	Transparente	270,00 €
F5600-50W-3K-DO	3K	Opalino	270,00 €
F5600-50W-4K-DO	4K	Opalino	270,00 €
F5600-50W-3K-SD	3K	Sin difusor	250,00 €
F5600-50W-4K-SD	4K	Sin difusor	250,00 €



F5600-50W
(sin difusor)

RESULTADOS FOTOMÉTRICOS

para la referencia F5600 OPAL

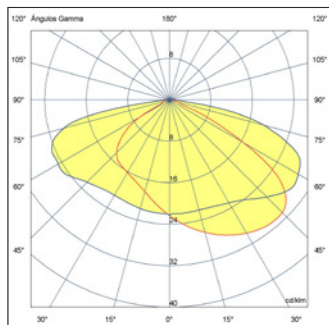

para la referencia F5600 TRANS

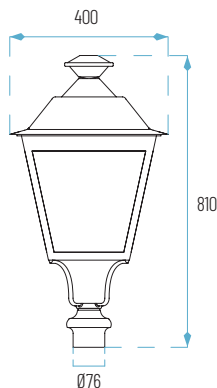
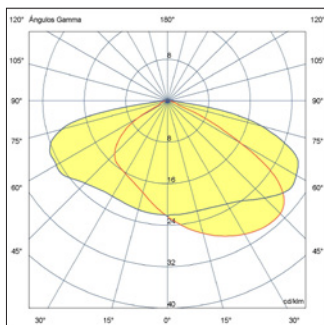

FAROLAS ALUMBRADO PÚBLICO LED

CRI >80 **FP >0.9** **IP 65** **RoHS** **CE** **Flicker Free** **MW MEAN WELL** **OSRAM** 480 x 675 x 240 mm
 OPCIONES **WiFi** **REG**

■ N: Negro

● Cálido

● Neutro

● Frío



F5800-40W

F5800 SEMIGLOBO LED-40W/60W/80W

- Difusor de policarbonato transparente
- Fuente con alto PFC y opciones de dimmado y control (MW HLG)
- Incluye un protector de sobretensiones transitorias
- Regulable 1/10V. Placa negra

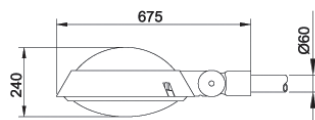

Lúmenes chip:

F5800-40W: 4300 lm

F5800-60W: 6400 lm

F5800-80W: 8600 lm

Lúmenes aplicación:

F5800-40W: 3495 lm

F5800-60W: 5239 lm

F5800-80W: 7434 lm

F5800-40W, 60W y 80W

P.V.

F5800-40W 3000K, 4000K o 5000K **325,00 €**

F5800-60W 3000K, 4000K o 5000K **350,00 €**

F5800-80W 3000K, 4000K o 5000K **380,00 €**

RESULTADOS FOTOMÉTRICOS

para la referencia F5800

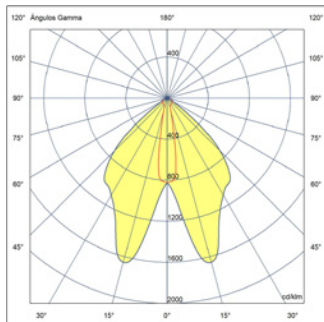

BRAZO DE FAROLA

para referencias F5600

BF5600-BF5700

P.V.

71,40 €

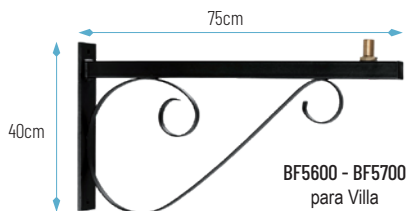

BF5600 - BF5700
para Villa

BRAZO DE FAROLA

para referencia F5800

BF5800

P.V.

55,20 €



BF5800
para Semiglobo

ACOPLE PARA POSTE

para referencias F5600

ACOP-F5600-F5700

P.V.

16,38 €



ACOP-F5600-F5700
para Villa

ACOPLE PARA POSTE

Ref.

ACOP-V5600

P.V.

33,90 €

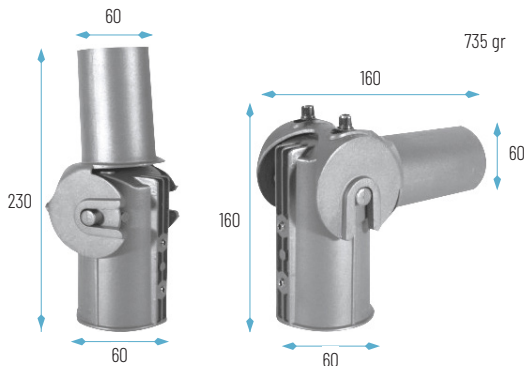

ACOPLES PARA FAROLAS ALUMBRADO PÚBLICO LED

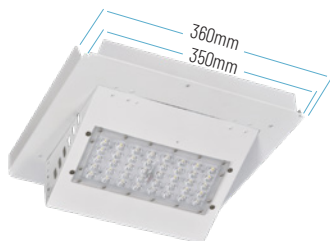
OPCIONES **WiFi** **REG** B: Blanco Cálido Neutro Frío

ACPLB-VIL40W4K

KIT BASCULANTE 40W

- Diferentes lentes asimétricas disponibles
- Incluye un protector de sobretensiones transitorias
- Consultar opciones de control y dimmado

Ref.	P.V.
ACPLB-VIL40W 3000K, 4000K o 5000K	231,00 €
ACPLB-FER-SEMI40W 3000K, 4000K o 5000K	231,00 €

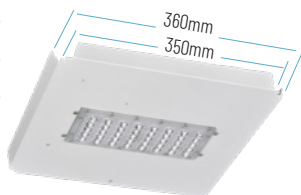

ACPLB-FER-SEMI40W

OPCIONES **WiFi** **REG** B: Blanco Cálido Neutro Frío

ACPLF-VIL40W4K

KIT PLACA FIJA 40W, 60W Y 80W

- Diferentes lentes asimétricas disponibles
- El montaje incluye la placa, el módulo LED, el driver Meanwell IP65 y la caja de conexiones con conectores IP65
- Incluye un protector de sobretensiones transitorias Consultar opciones de control y dimmado

Ref.	P.V.
ACPLF-VIL40W 3000K, 4000K o 5000K	207,90 €
ACPLF-FER-SEMI40W 3000K, 4000K o 5000K	207,90 €
ACPLF-FER-SEMI60W 3000K, 4000K o 5000K	300,30 €
ACPLF-FER-SEMI80W 3000K, 4000K o 5000K	309,75 €



ACPLF-SEMI60-80W4K