













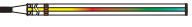

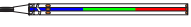



























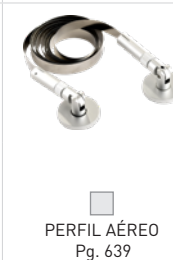
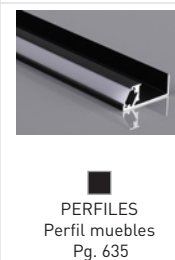
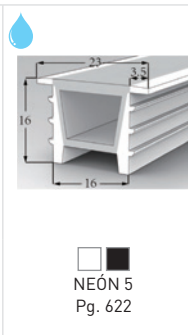
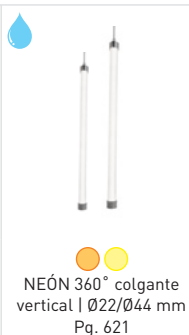
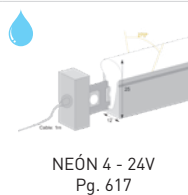
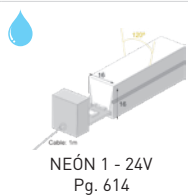

07. TIRAS LED - NEÓN

ÍNDICE VISUAL

 <p>220V AC Pg. 570</p>	 <p>TIRAS LED 24V COB 8W Monocolor Pg. 572</p>	 <p>TIRAS LED 24V COB 15W Monocolor Pg. 573</p>	 <p>TIRAS LED 24V COB 16W CDC Pg. 574</p>	 <p>RGB+ CDC TIRAS LED 24V COB 16W RGB+CDC Pg. 575</p>
 <p>RGB TIRAS LED 24V COB 15W RGB Pg. 576</p>	 <p>PÍXEL TIRAS LED 24V COB-DIG-14W Pg. 577</p>	 <p>TIRAS LED 24V 12W COB PÍXEL Pg. 578</p>	 <p>TIRAS LED 24V SMD 4,8W Monocolor Pg. 580</p>	 <p>TIRAS LED 24V SMD 4,8W Perimetral Monocolor Pg. 581</p>
 <p>TIRAS LED 24V SMD 10W Ultrafina Monocolor Pg. 582</p>	 <p>TIRAS LED 24V SMD 12W Monocolor Pg. 583</p>	 <p>TIRAS LED SMD 24V CRI95 Monocolor 7,6 W / 12W Pg. 584</p>	 <p>TIRAS LED SMD 24V 20W Monocolor Pg. 585</p>	 <p>TIRAS LED SMD 24V 26W Monocolor Pg. 586</p>
 <p>TIRAS LED SMD 24V 26W Doble Monocolor Pg. 587</p>	 <p>TIRAS LED SMD 24V 12W CDC Pg. 588</p>	 <p>RGB+ CDC TIRAS LED SMD 24V 25,5W RGB+CDC Pg. 589</p>	 <p>RGB TIRAS LED SMD 24V 12W RGB Pg. 590</p>	 <p>RGB+ (0 0 0) TIRAS LED SMD 24V 19,2W RGBW Pg. 591</p>
 <p>PÍXEL TIRAS LED 24V 14,4W PÍXEL Pg. 592</p>	 <p>TIRAS LED SMD 24V 12W Monocolor Pg. 593</p>	 <p>TIRAS LED SMD 24V 20W HORTICULTURA Crecimiento Pg. 594</p>	 <p>TIRAS LED SMD 24V 20W HORTICULTURA Floración 1 / Floración 2 Pg. 595</p>	 <p>TIRAS LED IP 24V 4,8W IP65 Pg. 600</p>
 <p>TIRAS LED IP 24V 12W IP65 Pg. 601</p>	 <p>TIRAS LED IP 24V 12W IP68 Pg. 602</p>	 <p>TIRAS LED IP 24V 26W IP65 Pg. 603</p>	 <p>TIRAS LED DOBLE IP 24V 26W DOBLE IP66 Pg. 604</p>	 <p>RGB TIRAS LED IP 24V 12W IP65 RGB Pg. 605</p>
 <p>RGB+ (0 0 0) TIRAS LED IP 24V 19,2W IP65 RGBW Pg. 606</p>	 <p>PÍXEL TIRAS LED IP 24V 14,4W IP65 PÍXEL Pg. 607</p>	 <p>TIRAS LED SMD 12V 4,8W Monocolor IP20 - IP65 - IP66 Pg. 610</p>	 <p>TIRAS LED SMD 12V 12W Monocolor IP20 - IP65 - IP66 Pg. 611</p>	 <p>RGB TIRAS LED SMD 12V 12W Monocolor IP20 - IP65 Pg. 612</p>



PERFILES RÍGIDOS ESTANCOS

 <p>  24V PE-IP40-4W Pg. 642 </p>	 <p>  24V PE-IP40-9W Pg. 642 </p>	 <p>  24V PE-IP40-18W Pg. 642 </p>
 <p>  24V PE-IP64-4W Pg. 643 </p>	 <p>  24V PE-IP64-9W Pg. 643 </p>	 <p>  24V PE-IP64-18W Pg. 643 </p>

MÓDULOS DE CARTELERÍA

 <p>  IP65 MLED4-1.44W-12V5K Pg. 646 </p>	 <p>  IP65 MLED2-0.72W-12V5K Pg. 647 </p>	 <p>  IP65 MLED3-1.08W-12V5K Pg. 648 </p>	 <p>  IP65 MLED1-4W-12V6K Pg. 649 </p>	 <p>  IP65 MLED1-2.2W-12V5K Pg. 650 </p>
 <p>   IP65 MLED4-1.44W-12VRGB Pg. 651 </p>				

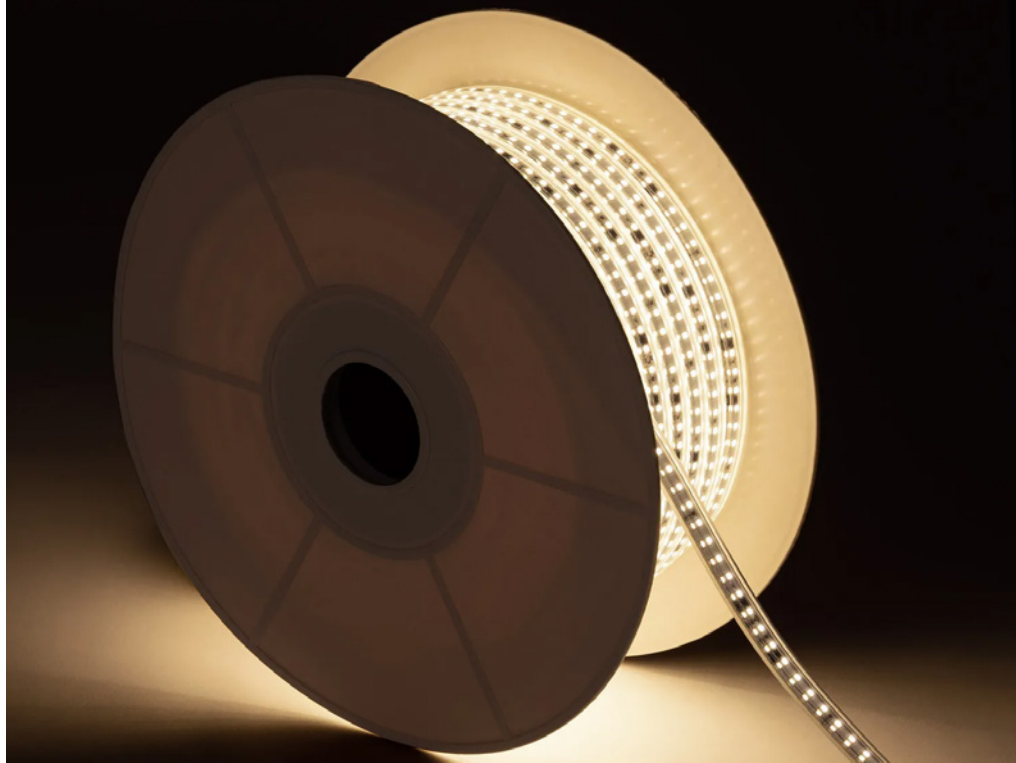

07. TIRAS LED

CONALUX LED

220V AC



- 2700K
- Cálido
- Neutro
- Frío

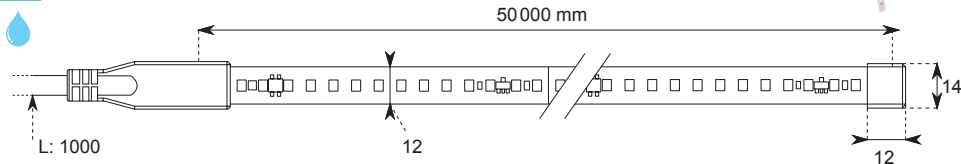

140 LEDs/metro	T.ª Color	lm/m	P.V. ● 50 m	P.V. ✂ 1m
AC220V-18W-IP65-2700K	● Cálido	1940 lm/m	850,00 €	18,40 €
AC220V-18W-IP65-3K	● Cálido	2070 lm/m	850,00 €	18,40 €
AC220V-18W-IP65-4K	● Neutro	2156 lm/m	850,00 €	18,40 €
AC220V-18W-IP65-6K	● Frío	2113 lm/m	850,00 €	18,40 €

	P.V.
AC220V-MPC Manipulación y corte tira LED 220V: Soldadura + 1 metro de cable	11,00 €



Kit cable alimentación (1 metro con fusible y tapa)

Ref.	P.V.
AC220V-ALI	9,60 €



Tapa de silicona

Ref.	P.V.
AC220V-TAPA	0,60 €



Kit grapas y tornillos

Ref.	P.V.
AC220V-GRF	1,90 €



Funda de silicona

Ref.	P.V.
AC220V-FUNDA	0,90 €



PCB protección cortocircuito y sobretensiones

Ref.	P.V.
AC220V-FUSIBLE	4,60 €

Pegamento de silicona



Ref.	P.V.
AC220V-SILICONA	4,70 €

Para mejorar la disipación debe utilizarse perfil o pletina de aluminio

07. TIRAS LED

CONALUX LED

COB 8W MONOCOLOR

COB 24V



- Cálido
- Neutro
- Frío

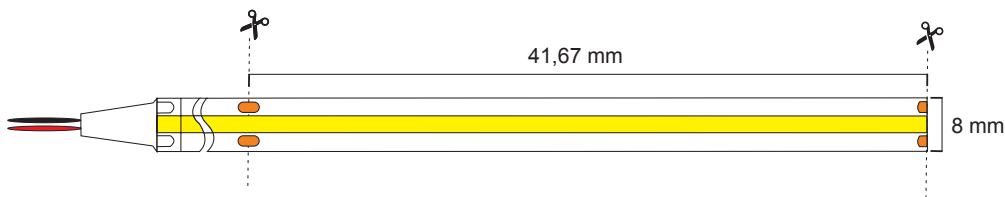

504 LEDs/metro	T. ^a Color	lm/m	P.V. ● 20 m	P.V. ✂ 1m
COB-8W-IP20-24V-3K	● Cálido	900 lm/m	77,80 €	6,30 €
COB-8W-IP20-24V-4K	● Neutro	923 lm/m	77,80 €	6,30 €
COB-8W-IP20-24V-6K	● Frío	950 lm/m	77,80 €	6,30 €

Manipulación: Soldadura + 1 metro de cable	P.V. 3,50 €
--	----------------

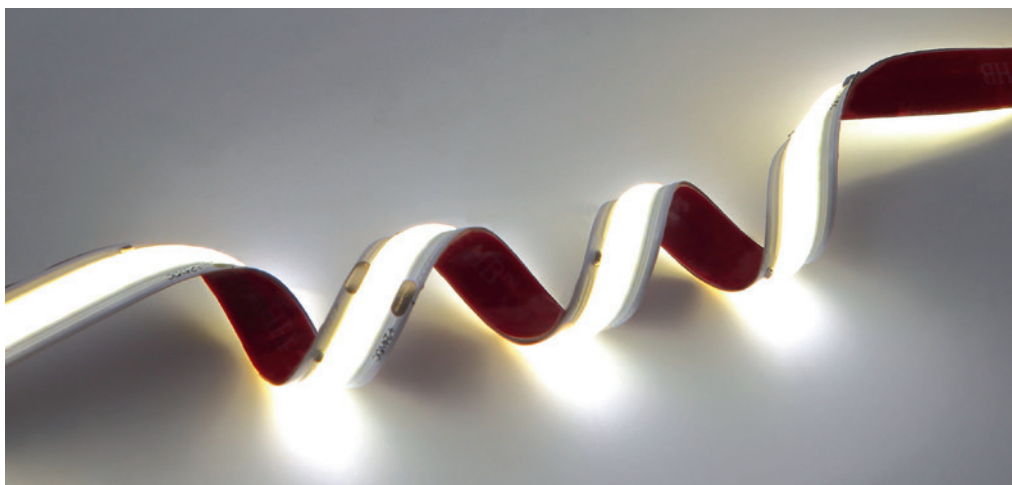

Para mejorar la disipación debe utilizarse perfil o pletina de aluminio



- Cálido
- Neutro
- Frío

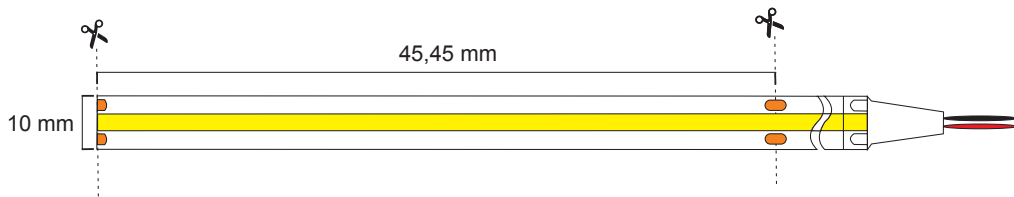

528 LEDs/metro	T. ^a Color	lm/m	P.V. ● 10 m	P.V. ✂ 1m
COB-15W-IP20-24V-3K	● Cálido	1706 lm/m	98,80 €	11,80 €
COB -15W-IP20-24V-4K	● Neutro	1883 lm/m	98,80 €	11,80 €
COB -15W-IP20-24V-6K	● Frío	1885 lm/m	98,80 €	11,80 €

	P.V.
Manipulación: Soldadura + 1 metro de cable	3,50 €

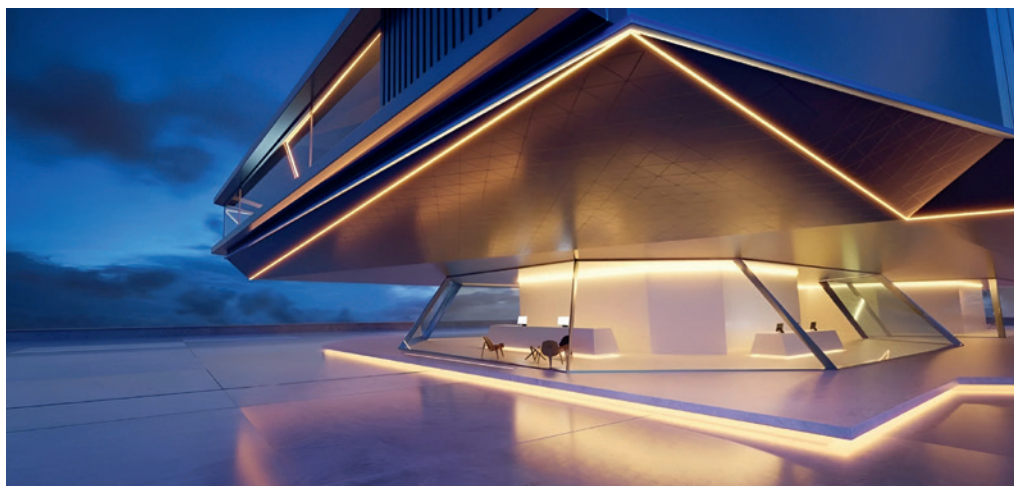

Para mejorar la disipación debe utilizarse perfil o pletina de aluminio

07. TIRAS LED

CONALUX LED

COB CDC

COB 24V

IP 20 **W 16** **640 led/m** **CRI >80** **20,83 mm** **24V** **110 lm/W** **3 AÑOS DE GARANTÍA** **CE** **RoHS** **MacAdam 3-STEP** **4000K** **COB CDC**

● ● ● CDC

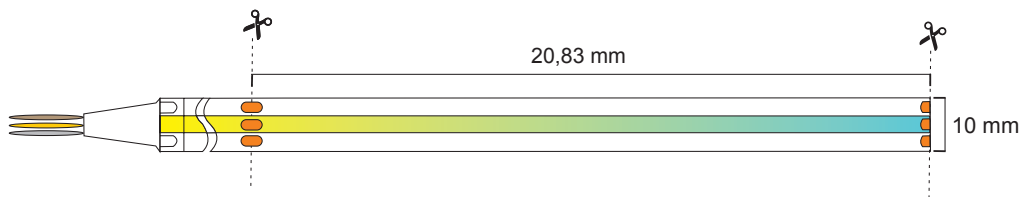

640 LEDs/metro	T. ^a Color	lm/m	P.V. ● 10 m	P.V. ✂ 1m
COB-CDC-16W-IP20-24V	● ● ●	1760 lm/m	160,80 €	19,80 €

Manipulación: Soldadura + 1 metro de cable	P.V.
	3,50 €



Para mejorar la disipación debe utilizarse perfil o pletina de aluminio

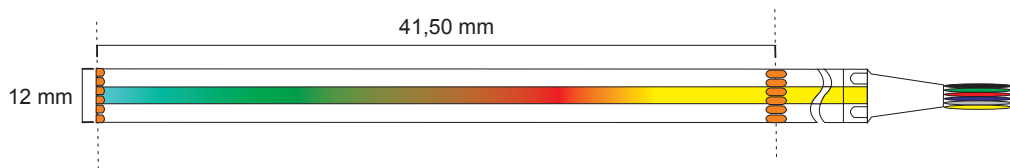

840 LEDs/metro	T.ª Color	lm/m	P.V. ● 10 m
COB-RGB+CDC-16W-IP20-24V	RGB+ ● ● ● ●	1808 lm/m	174,40 €

No admite corte ni manipulación



Para mejorar la disipación debe utilizarse perfil o pletina de aluminio

07. TIRAS LED

CONALUX LED

COB RGB

COB 24V



RGB

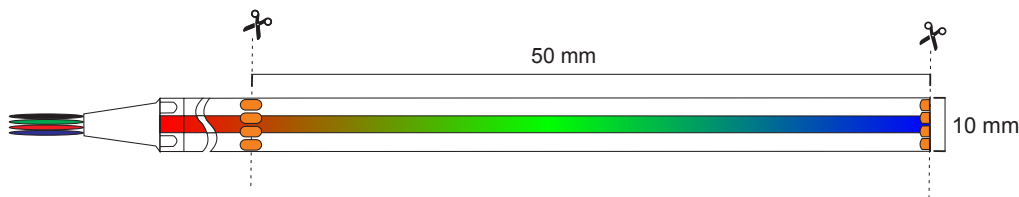

640 LEDs/metro	T. ^a Color	lm/m	P.V. ● 10 m	P.V. ✂ 1m
COB-RGB-15W-IP20-24V	RGB	1500 lm/m	143,60 €	18,00 €

Manipulación: Soldadura + 1 metro de cable	P.V.
	5,50 €



Para mejorar la disipación debe utilizarse perfil o pletina de aluminio

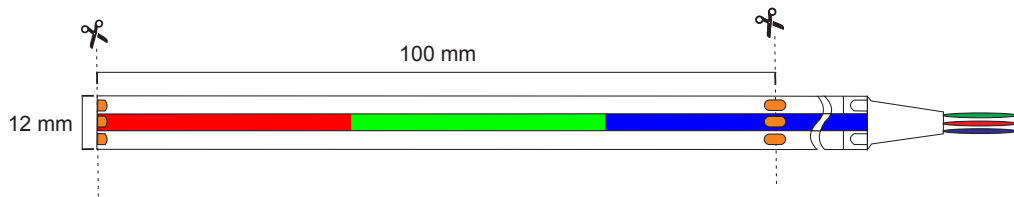

670 LEDs/metro	T. ^a Color	lm/m	P.V. ● 10 m	P.V. ✂ 1m
COB-DIG-14W-IP20-24V	PÍXEL	1500 lm/m	143,60 €	19,00 €

	P.V.
Manipulación: Soldadura + 1 metro de cable	13,00 €



Para mejorar la disipación debe utilizarse perfil o pletina de aluminio

07. TIRAS LED

CONALUX LED

COB PIXEL

COB 24V

IP 20 **W 12** **360 led/m** **CRI >80** **83,3 mm** **24V** **110 lm/W** **3 AÑOS DE GARANTÍA** **CE** **RoHS** **MacAdam 3-STEP**

- Cálido
- Neutro

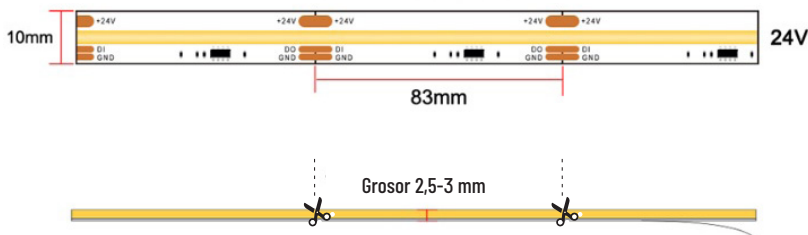

360 LEDs/metro	T.ª Color	lm/W	P.V. 10 m	P.V. 1m
COB-PIXEL-12W-IP20-24V-2,7K-10M	● Cálido	110 lm/W	98,00 €	10,70 €
COB-PIXEL-12W-IP20-24V-4K-10M	● Neutro	110 lm/W	98,00 €	10,70 €

Manipulación: Soldadura + 1 metro de cable	P.V.
	5,50 €

Para mejorar la disipación debe utilizarse perfil o pletina de aluminio



TIRAS LED SMD

07. TIRAS LED

4,8W MONOCOLOR

CONALUX LED

SMD 24V



- Cálido
- Neutro
- Frío

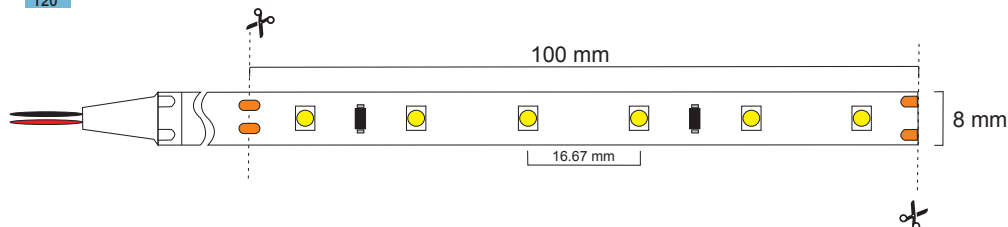

60 LEDs/metro	T.ª Color	lm/m	P.V. ● 50 m	P.V. ● 5 m	P.V. ✂ 1m
4.8W-IP20-24V-3K	● Cálido	395 lm/m	192,00 €	21,95 €	5,90 €
4.8W-IP20-24V-4K	● Neutro	417 lm/m	192,00 €	21,95 €	5,90 €
4.8W-IP20-24V-6K	● Frío	454 lm/m	192,00 €	21,95 €	5,90 €

Manipulación: Soldadura + 1 metro de cable

P.V.

3,50 €



Para mejorar la disipación debe utilizarse perfil o pletina de aluminio

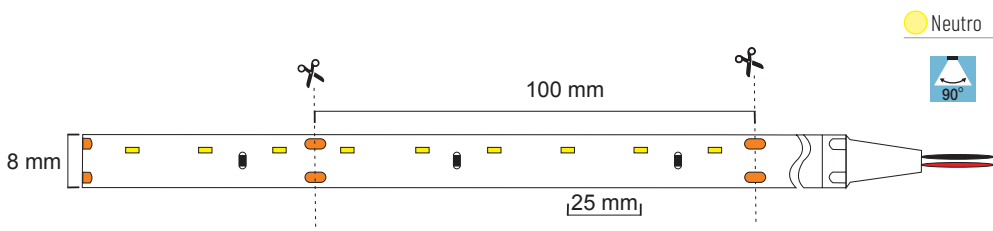
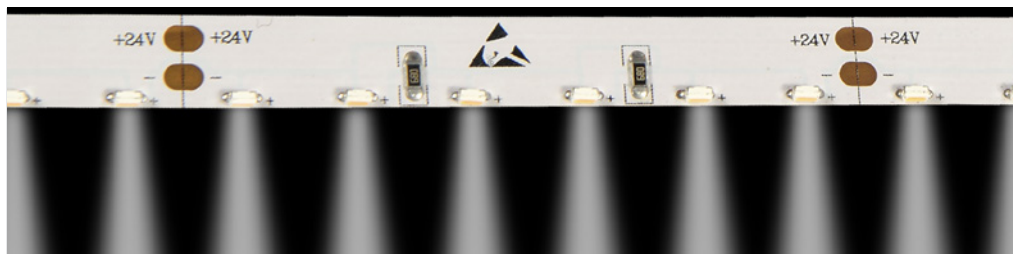

60 LEDs/metro	Tipo de LED	T. ^a Color	P.V. ● 5 m	P.V. ✂ 1m
PERIMETRAL-4.8W-IP20-24V-4K	LED SMD 335	● Neutro	43,20 €	11,20 €

Manipulación: Soldadura + 1 metro de cable	P.V.
	3,50 €



Para mejorar la disipación debe utilizarse perfil o pletina de aluminio

07. TIRAS LED

CONALUX LED

ULTRAFINA MONOCOLOR

SMD 24V



- Cálido
- Neutro
- Frío

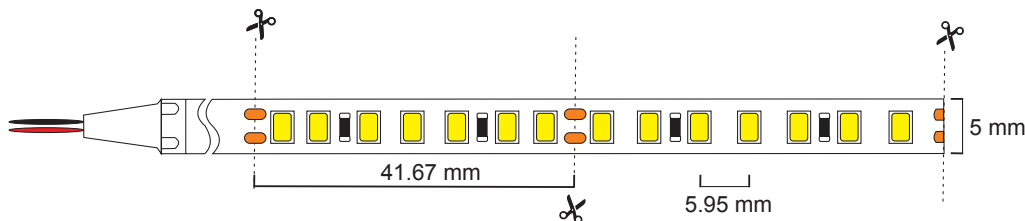

168 LEDs/metro	T. ^a Color	lm/m	P.V. ● 20 m	P.V. ✂ 1m
ULTRAFINA-10W-IP20-24V-3K	● Cálido	1312 lm/m	138,40 €	10,34 €
ULTRAFINA-10W-IP20-24V-4K	● Neutro	1355 lm/m	138,40 €	10,34 €
ULTRAFINA-10W-IP20-24V-6K	● Frío	1326 lm/m	138,40 €	10,34 €

	P.V.
Manipulación: Soldadura + 1 metro de cable	3,50 €



Para mejorar la disipación debe utilizarse perfil o pletina de aluminio



- 1700K
- 2700K
- Cálido
- Neutro
- Frío

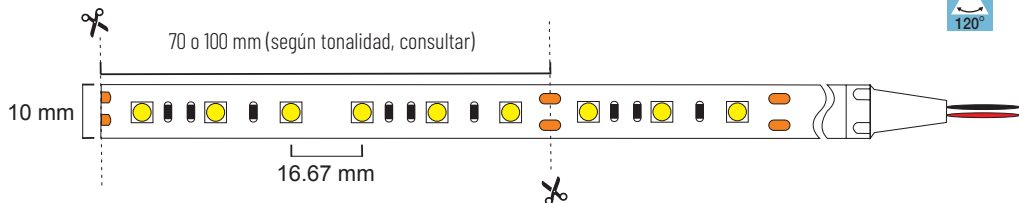

70 LEDs/metro	T.ª Color	lm/m	P.V. ● 50 m	P.V. ● 5 m	P.V. ✂ 1m
12W-IP20-24V-1700K	● 1700K	1080 lm/m	284,00 €	29,90 €	9,50 €
12W-IP20-24V-2700K	● 2700K	1250 lm/m	226,00 €	25,00 €	8,50 €
12W-IP20-24V-3K	● Cálido	1195 lm/m	226,00 €	25,00 €	8,50 €
12W-IP20-24V-4K	● Neutro	1224 lm/m	226,00 €	25,00 €	8,50 €
12W-IP20-24V-6K	● Frío	1224 lm/m	226,00 €	25,00 €	8,50 €

P.V.
3,50 €

Manipulación: Soldadura + 1 metro de cable



Para mejorar la disipación debe utilizarse perfil o pletina de aluminio

07. TIRAS LED

CONALUX LED

CRI 95 MONOCOLOR

SMD 24V



- Cálido
- Neutro
- Frío

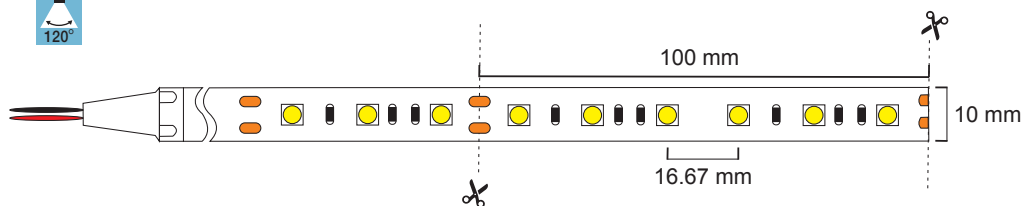

60 LEDs/metro	T. ^a Color	lm/m	P.V. ● 50 m	P.V. ● 10 m	P.V. ✂ 1m
CRI95-7.6W-IP20-24V-3K	● Cálido	764 lm/m	389,00 €	76,80 €	11,22 €
CRI95-7.6W-IP20-24V-4K	● Neutro	778 lm/m	389,00 €	76,80 €	11,22 €
CRI95-7.6W-IP20-24V-6K	● Frío	792 lm/m	389,00 €	76,80 €	11,22 €

60 LEDs/metro	T. ^a Color	lm/m	P.V. ● 50 m	P.V. ✂ 1m
CRI95-12W-IP20-24V-3K	● Cálido	1064 lm/m	389,00 €	11,22 €
CRI95-12W-IP20-24V-4K	● Neutro	1078 lm/m	389,00 €	11,22 €
CRI95-12W-IP20-24V-6K	● Frío	1092 lm/m	389,00 €	11,22 €

Manipulación: Soldadura + 1 metro de cable P.V. 3,50 €

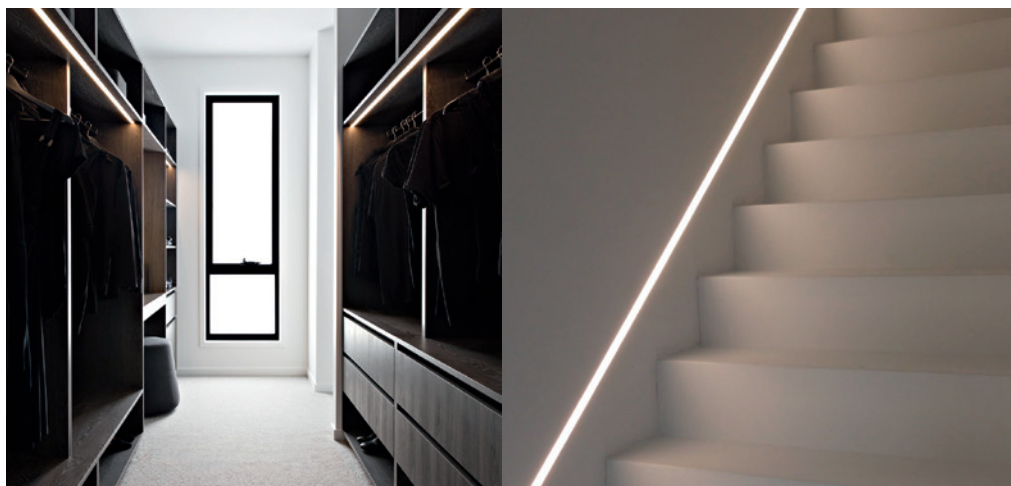

Para mejorar la disipación debe utilizarse perfil o pletina de aluminio



- Cálido
- Neutro
- Frío

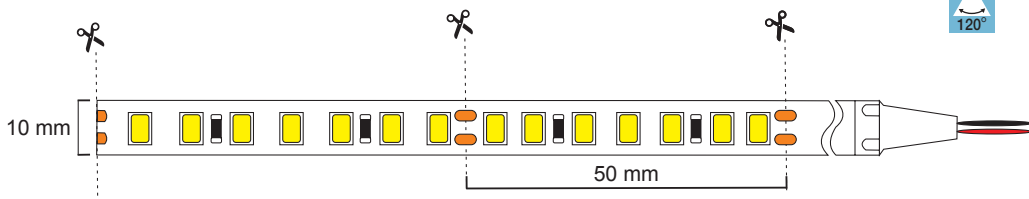

140 LEDs/metro	T.ª Color	lm/m	P.V. ● 50 m	P.V. ✂ 1m
20W-IP20-24V-3K	● Cálido	2244 lm/m	346,00 €	10,60 €
20W-IP20-24V-4K	● Neutro	2546 lm/m	346,00 €	10,60 €
20W-IP20-24V-5K	● Frío	2534 lm/m	346,00 €	10,60 €

Manipulación: Soldadura + 1 metro de cable P.V. 3,50 €



Para mejorar la disipación debe utilizarse perfil o pletina de aluminio

07. TIRAS LED

CONALUX LED

26W MONOCOLOR

SMD 24V



- Cálido
- Neutro
- Frío

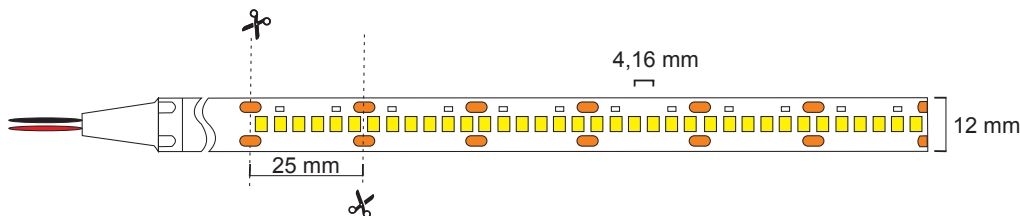

240 LEDs/metro	T. ^a Color	lm/m	P.V. ● 50 m	P.V. ● 5 m	P.V. ⌘ 1m
26W-IP20-24V-3K	● Cálido	2340 lm/m	650,00 €	68,90 €	17,74 €
26W-IP20-24V-4K	● Neutro	2418 lm/m	650,00 €	68,90 €	17,74 €
26W-IP20-24V-6K	● Frío	2418 lm/m	650,00 €	68,90 €	17,74 €

Manipulación: Soldadura + 1 metro de cable	P.V.
	3,50 €

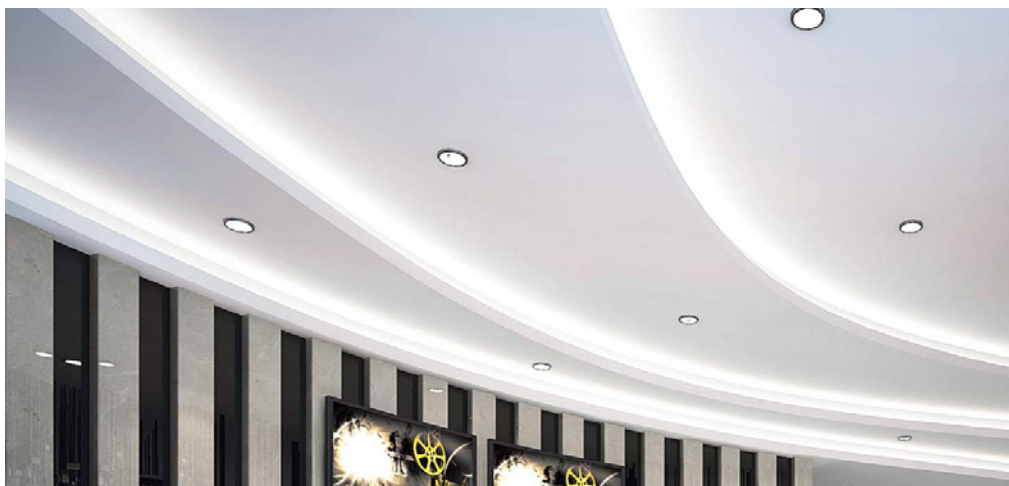

Para mejorar la disipación debe utilizarse perfil o pletina de aluminio



- Cálido
- Neutro
- Frío

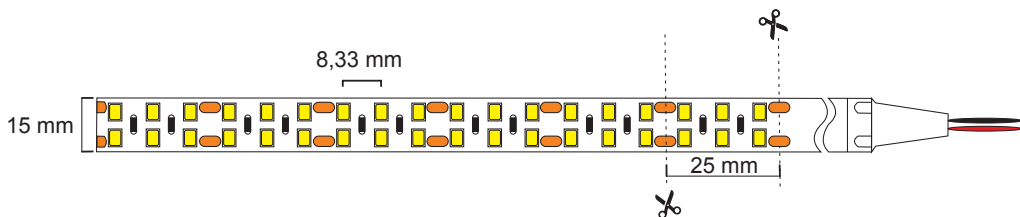

240 LEDs/metro	T. ^a Color	lm/m	P.V. ● 50 m	P.V. ● 5 m	P.V. ✂ 1m
26WDOBLE-IP20-24V-3K	● Cálido	2880 lm/m	650,00 €	68,90 €	17,74 €
26WDOBLE-IP20-24V-4K	● Neutro	2976 lm/m	650,00 €	68,90 €	17,74 €
26WDOBLE-IP20-24V-6K	● Frío	2976 lm/m	650,00 €	68,90 €	17,74 €

P.V.

Manipulación: Soldadura + 1 metro de cable 3,50 €



Para mejorar la disipación debe utilizarse perfil o pletina de aluminio

07. TIRAS LED

CONALUX LED

TIRAS CDC

SMD 24V

IP 20 **W 12** **120 led/m** **CRI >80** **10 cm** **24V** **80 lm/W** **3 AÑOS DE GARANTÍA** **CE** **RoHS** **MacAdam 3-STEP** **100% SMD 24V CDC**

● ● ● CDC



2700K	6W	468lm
Mixta 4000K	Máx. 12W	968lm
6500K	6W	468lm

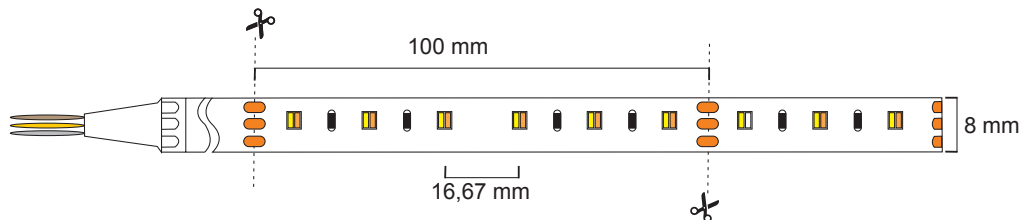

120 LEDs/metro	T.ª Color	P.V. 5 m	P.V. 1m
CDC-12W-IP20-24V	● ● ● CDC	73,20 €	21,20 €

Manipulación: Soldadura + 1 metro de cable	P.V.
	3,50 €



Para mejorar la disipación debe utilizarse perfil o pletina de aluminio

SMD 24V

RGB + CDC



Rojo	4,1W	109,3lm
Verde	4,9W	323,5lm
Azul	4,7W	57,9lm
Blanco cálido	6,1W	635,5lm
Blanco frío	6,2W	703,8lm
Mixto	25,5W	1742,4lm

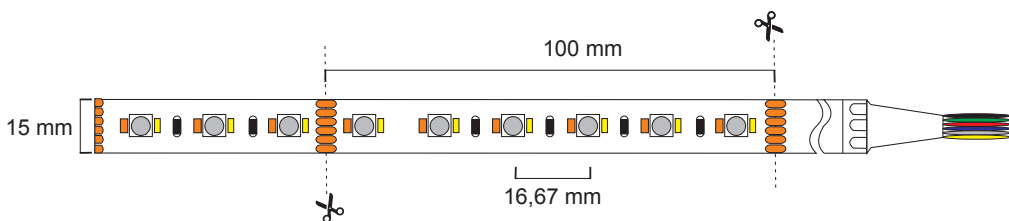

180 LEDs/metro

RGB+CDC-25,5W-IP20-24V



W/m

25,5 W/m

P.V. 5 m

76,20 €

P.V. 1m

23,20 €

Manipulación: Soldadura + 1 metro de cable

P.V.

3,50 €



Para mejorar la disipación debe utilizarse perfil o pletina de aluminio

07. TIRAS LED

CONALUX LED

RGB

SMD 24V



RGB			
Rojo	4,2W	97lm	
Verde	4,2W	246lm	
Azul	4,2W	42lm	
Mixto	12W	432lm	

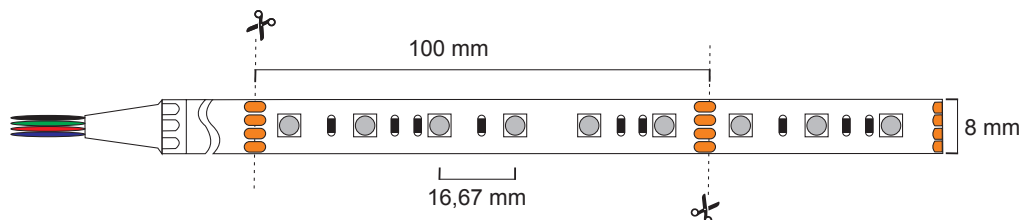

60 LEDs/metro	T.ª Color	P.V. ● 50 m	P.V. ● 5 m	P.V. ✂ 1m
RGB-12W-IP20-24V	RGB	380,00 €	36,20 €	8,55 €

Manipulación: Soldadura + 1 metro de cable	P.V.
	5,5 €



Para mejorar la disipación debe utilizarse perfil o pletina de aluminio

SMD 24V

RGBW (RGB + Cálido o Frío)



Rojo	4,8W	53lm
Verde	4,8W	149lm
Azul	4,8W	26lm
Blanco	4,8W	612lm
Mixto	19,2W	763lm

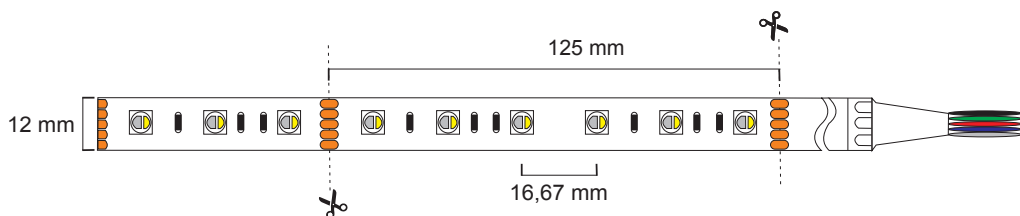

60 LEDs/metro	T. ^a Color	P.V. ● 50 m	P.V. ● 5 m	P.V. ✂ 1m
RGB+C-19.2W-IP20-24V	RGB + Cálido	624,00 €	62,40 €	19,00 €
RGB+F-19.2W-IP20-24V	RGB + Frío	624,00 €	62,40 €	19,00 €

Manipulación: Soldadura + 1 metro de cable	P.V.
	5,5 €



Para mejorar la disipación debe utilizarse perfil o pletina de aluminio

07. TIRAS LED

CONALUX LED

PÍXEL

SMD 24V



PÍXEL

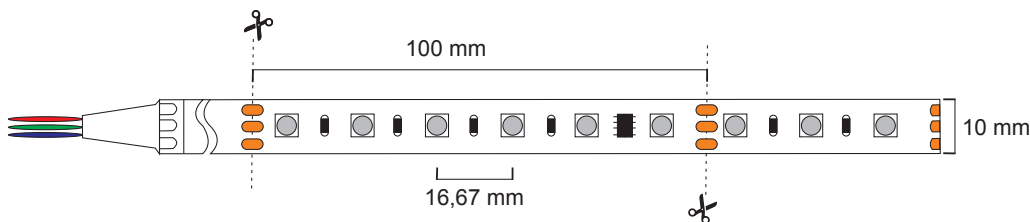

60 LEDs/metro	T. ^a Color	W/m	P.V. ● 5 m	P.V. ✂ 1m
LED-PIXEL-14,4W-IP20-24V	PÍXEL	14,4 W/m	60,80 €	20,00 €

Manipulación: Soldadura + 1 metro de cable	P.V.
	3,50 €



Para mejorar la disipación debe utilizarse perfil o pletina de aluminio

SMD 24V

12W ROJO-VERDE-AZUL-ROSA MONOCOLOR

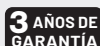

● Rojo

● Verde

● Azul

● Rosa

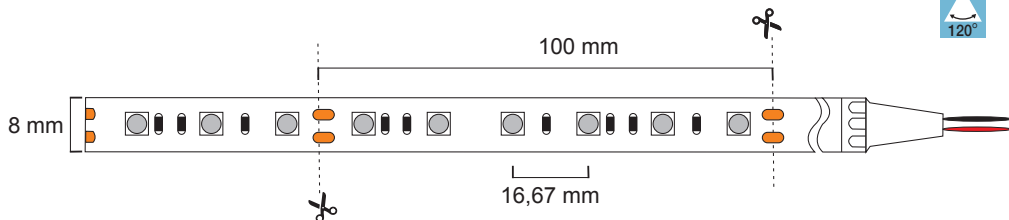

60 LEDs/metro	T.ª Color	lm/m	P.V. ● 50 m	P.V. ✂ 1m
12W-IP20-24V-ROJO	● Rojo	1080 lm/m	420,00 €	12,81 €
12W-IP20-24V-VERDE	● Verde	1080 lm/m	420,00 €	12,81 €
12W-IP20-24V-AZUL	● Azul	1080 lm/m	420,00 €	12,81 €
12W-IP20-24V-ROSA	● Rosa	1080 lm/m	420,00 €	12,81 €

	P.V.
Manipulación: Soldadura + 1 metro de cable	3,50 €



Para mejorar la disipación debe utilizarse perfil o pletina de aluminio

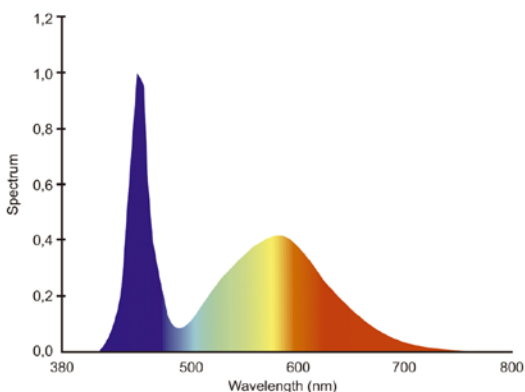
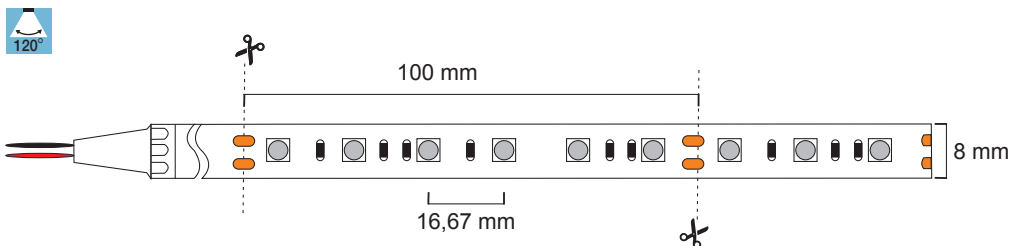

CRECIMIENTO

- Tira LED 20W, para fomentar el crecimiento de plantas
- Espectro luminoso amplio, con predominancia de azules
- 120 LEDs/m 24 VDC
- Sistemas de control y regulación disponibles

120 LEDs/metro	Medidas	W/m	P.V. ● 5 m
H.CRECIMIENTO	5000 x 22 mm	20 W/m	77,00 €

Para mejorar la disipación debe utilizarse perfil o pletina de aluminio

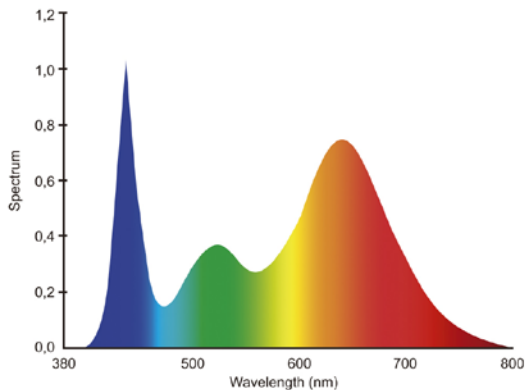

FLORACIÓN 1

- Tira LED 20W, para floración de plantas
- Recomendada para plantas con pocas hojas
- Predominación de rojos
- 120 LEDs/m 24 VDC
- Sistemas de control y regulación disponibles

120 LEDs/metro	Medidas	W/m	P.V. ● 5 m
H.FLORACION1	5000 x 22 mm	20 W/m	80,85 €

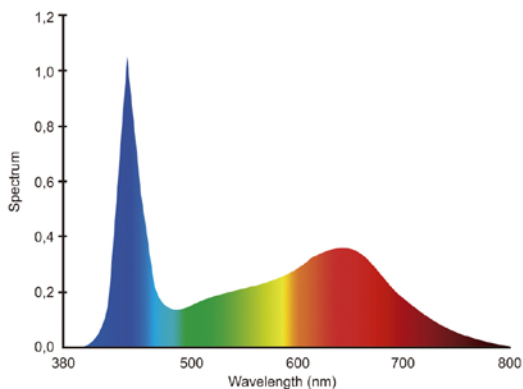

FLORACIÓN 2

- Tira LED 20W, para floración de plantas
- Recomendada para plantas con muchas hojas
- Predominación de rojos
- 120 LEDs/m 24 VDC
- Sistemas de control y regulación disponibles

120 LEDs/metro	Medidas	W/m	P.V. ● 5 m
H.FLORACION2	5000 x 22 mm	20 W/m	80,85 €

Para mejorar la disipación debe utilizarse perfil o pletina de aluminio

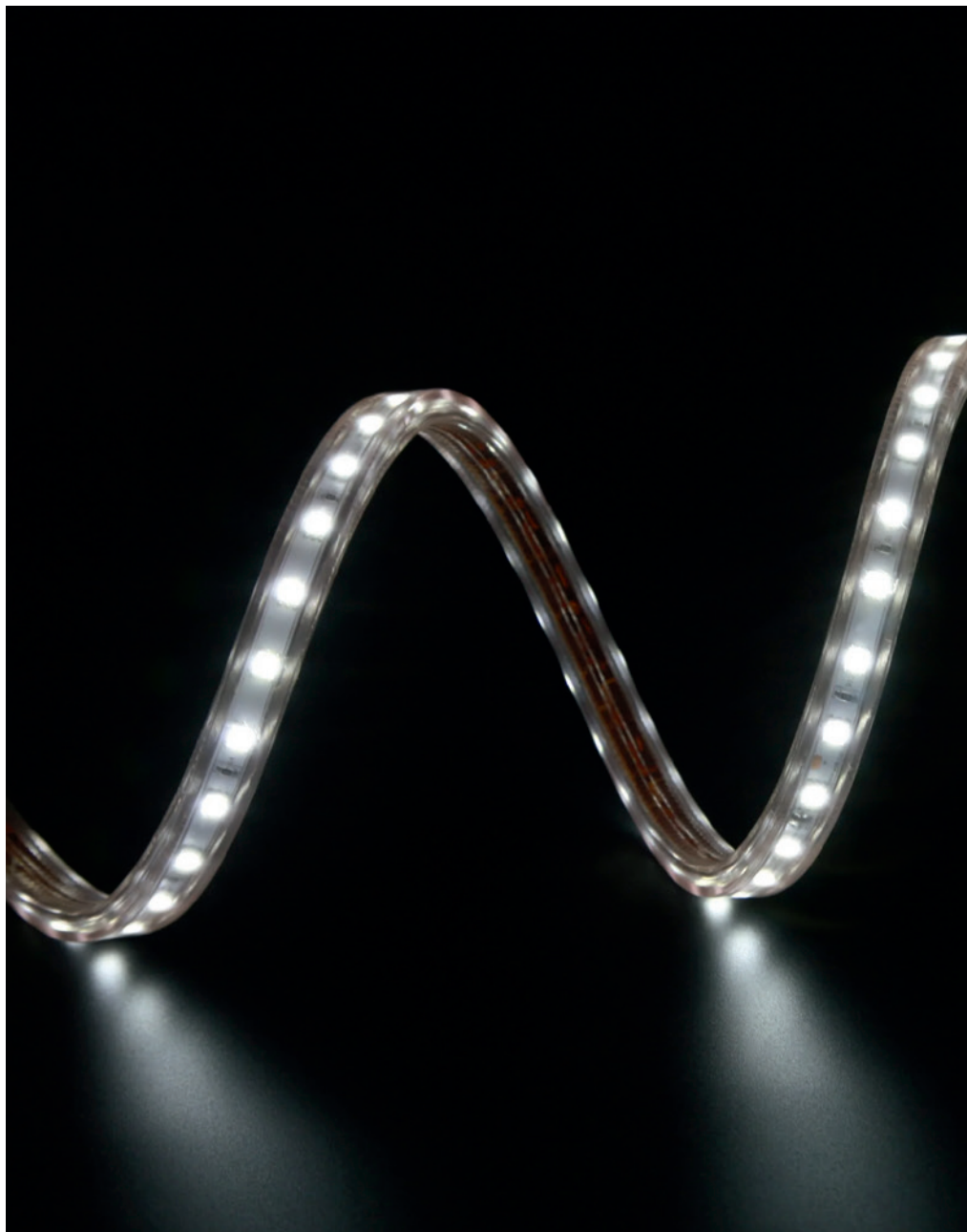

TIRAS LED IP





07. TIRAS LED

CONALUX LED

4,8W IP65

IP 24V



- Cálido
- Neutro
- Frío

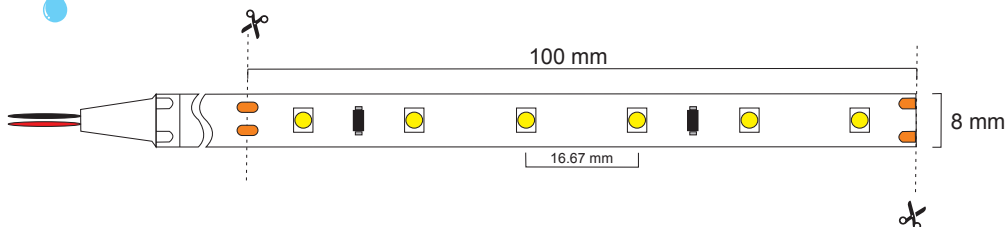

60 LEDs/metro	T. ^a Color	lm/m	P.V. ● 10 m	P.V. ✂ 1m
4,8W-IP65-24V-3K	● Cálido	395 lm/m	58,40 €	6,50 €
4,8W-IP65-24V-4K	● Neutro	417 lm/m	58,40 €	6,50 €
4,8W-IP65-24V-6K	● Frío	454 lm/m	58,40 €	6,50 €

Manipulación: Soldadura + 1 metro de cable	P.V.
	7,50 €

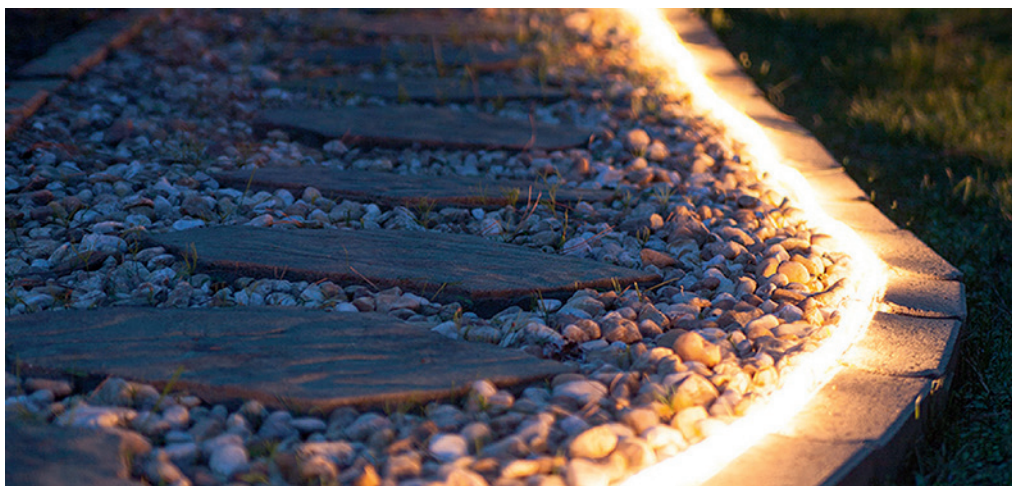

Para mejorar la disipación debe utilizarse perfil o pletina de aluminio

MacAdam 3-STEP RoHS CE 3 AÑOS DE GARANTÍA 24V 10 cm CRI >80 60 led/m W 12 IP 65

- Cálido
- Neutro
- Frío

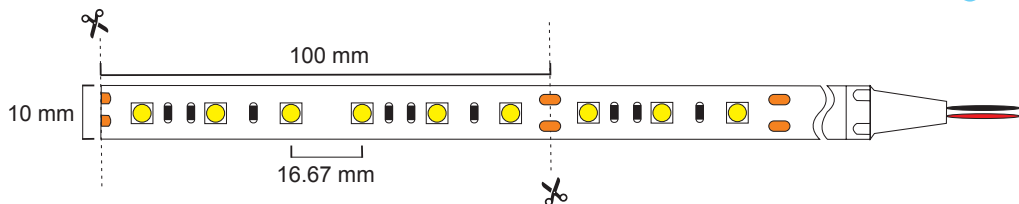

60 LEDs/metro	T. ^a Color	lm/m	P.V. ● 10 m	P.V. ● 5 m	P.V. ✂ 1m
12W-IP65-24V-3K	● Cálido	1195 lm/m	79,00 €	41,00 €	13,00 €
12W-IP65-24V-4K	● Neutro	1224 lm/m	79,00 €	41,00 €	13,00 €
12W-IP65-24V-6K	● Frío	1224 lm/m	79,00 €	41,00 €	13,00 €

	P.V.
Manipulación: Soldadura + 1 metro de cable	7,50 €



Para mejorar la disipación debe utilizarse perfil o pletina de aluminio

07. TIRAS LED

CONALUX LED

12W IP68

IP 24V



- Cálido
- Neutro
- Frío

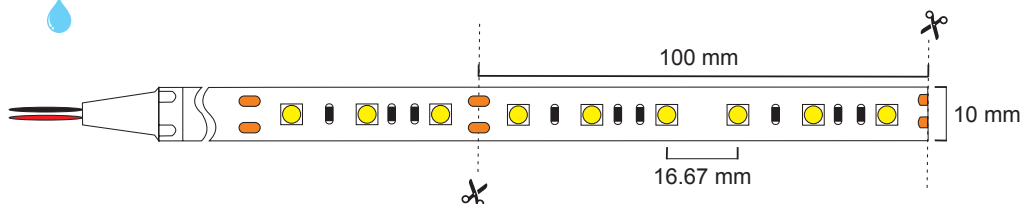

60 LEDs/metro	T. ^a Color	lm/m	P.V. ● 10 m
12W-IP68-24V-3K	● Cálido	1195 lm/m	104,00 €
12W-IP68-24V-4K	● Neutro	1224 lm/m	104,00 €
12W-IP68-24V-6K	● Frío	1224 lm/m	104,00 €

*NO instalar en aguas tratadas con productos químicos. Pueden dañar el recubrimiento.



Para mejorar la disipación debe utilizarse perfil o pletina de aluminio



- Cálido
- Neutro
- Frío

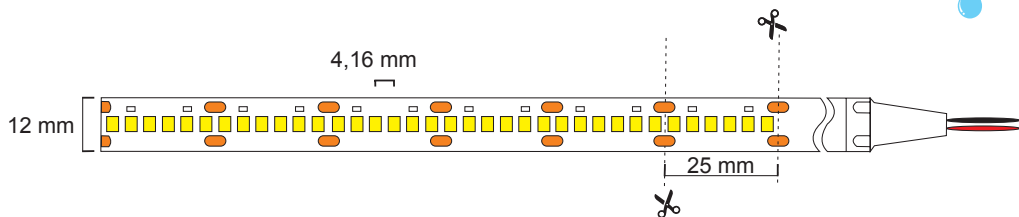

240 LEDs/metro	T. ^a Color	lm/m	P.V. ● 10 m	P.V. ✂ 1m
26W-IP65-24V-3K	● Cálido	2340 lm/m	183,54 €	24,50 €
26W-IP65-24V-4K	● Neutro	2418 lm/m	183,54 €	24,50 €
26W-IP65-24V-6K	● Frío	2418 lm/m	183,54 €	24,50 €

Manipulación: Soldadura + 1 metro de cable	P.V. 7,50 €
--	----------------



Para mejorar la disipación debe utilizarse perfil o pletina de aluminio

07. TIRAS LED

CONALUX LED

26W DOBLE IP66

IP 24V



- Cálido
- Neutro
- Frío

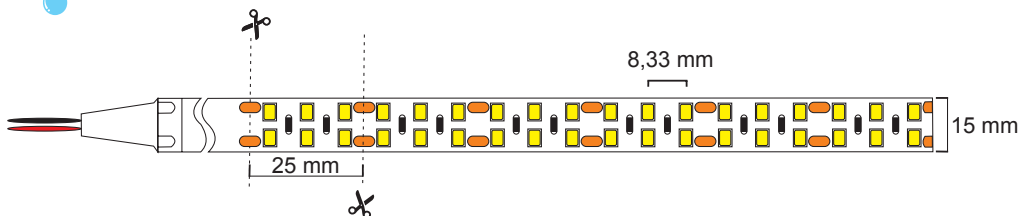

240 LEDs/metro	T. ^a Color	lm/m	P.V. ● 10 m	P.V. ✂ 1m
26WDOBLE-IP66-24V-3K	● Cálido	2880 lm/m	160,00 €	24,50 €
26WDOBLE-IP66-24V-4K	● Neutro	2976 lm/m	160,00 €	24,50 €
26WDOBLE-IP66-24V-6K	● Frío	2976 lm/m	160,00 €	24,50 €

P.V.
7,50 €

Manipulación: Soldadura + 1 metro de cable



Para mejorar la disipación debe utilizarse perfil o pletina de aluminio



3 AÑOS DE GARANTÍA

24V

10 cm

CRI >80

60 led/m

W 12

IP 65

Rojo	4,2W	97lm
Verde	4,2W	246lm
Azul	4,2W	42lm
Mixto	12W	432lm

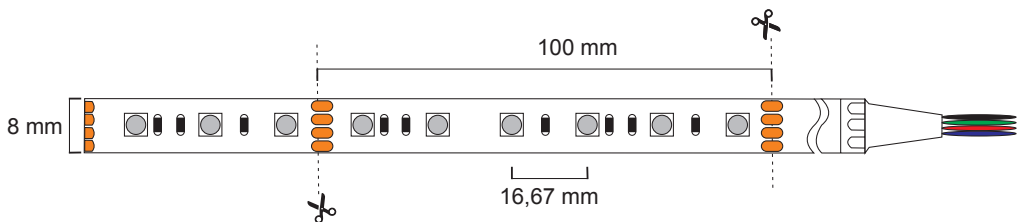

60 LEDs/metro	T. ^a Color	P.V. ● 20 m	P.V. ✂ 1m
RGB-12W-IP65-24V	RGB	188,80 €	15,20 €

Manipulación: Soldadura + 1 metro de cable	P.V.
	7,50 €

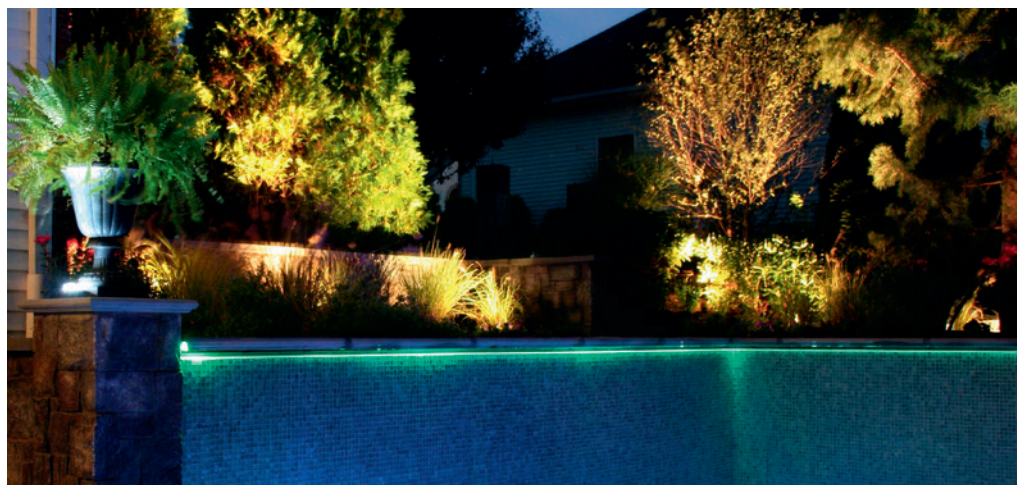

Para mejorar la disipación debe utilizarse perfil estanco

07. TIRAS LED

CONALUX LED

RGBW (RGB + Cálido o Frío) IP65

IP 24V



RGB + Cálido
RGB + Frío

Rojo	4,8W	53lm
Verde	4,8W	149lm
Azul	4,8W	26lm
Blanco	4,8W	612lm
Mixto	19,2W	763lm

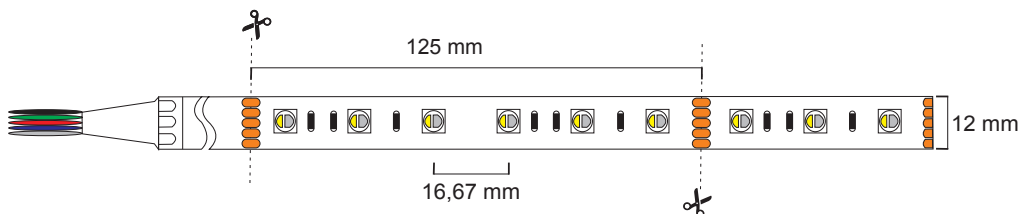

60 LEDs/metro	T.ª Color	lm/m	P.V. ● 10 m	P.V. ● 5 m	P.V. ✂ 1m
RGB+C-19,2W-IP65-24V	RGB + Cálido	960 lm/m	128,00 €	64,00 €	18,00 €
RGB+F-19,2W-IP65-24V	RGB + Frío	1080 lm/m	128,00 €	64,00 €	18,00 €



Para mejorar la disipación debe utilizarse perfil o pletina de aluminio

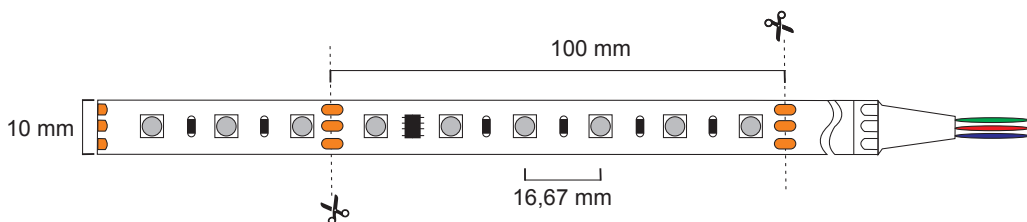

60 LEDs/metro	T.ª Color	W/m	P.V. ● 5 m	P.V. ✂ 1m
LED-PIXEL-14,4W-IP65- 24V	🌈 PÍXEL	14,4W/m	73,40 €	23,00 €



Para mejorar la disipación debe utilizarse perfil o pletina de aluminio



TIRAS LED SMD 12V

07. TIRAS LED

CONALUX LED

4,8W MONOCOLOR

SMD 12V



- Cálido
- Neutro
- Frío

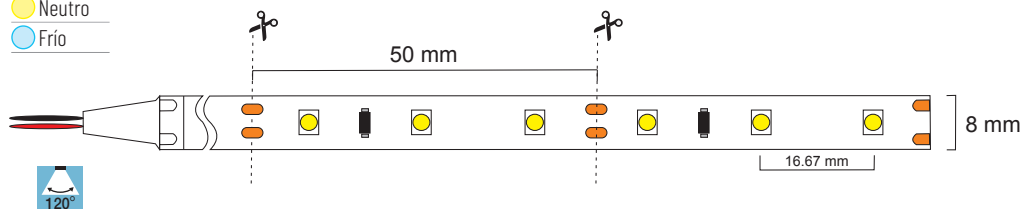

IP20 60 LEDs/metro	T. ^a Color	lm/m	P.V. ● 5 m
4,8W-IP20-12V-4K	● Neutro	417 lm/m	21,90 €
4,8W-IP20-12V-6K	● Frío	454 lm/m	21,90 €

IP65 60 LEDs/metro	T. ^a Color	lm/m	P.V. ● 5 m
4,8W-IP65-12V-3K	● Cálido	395 lm/m	29,20 €
4,8W-IP65-12V-4K	● Neutro	417 lm/m	29,20 €
4,8W-IP65-12V-6K	● Frío	454 lm/m	29,20 €

IP66 60 LEDs/metro	T. ^a Color	lm/m	P.V. ● 5 m
4,8W-IP66-12V-3K	● Cálido	395 lm/m	29,20 €
4,8W-IP66-12V-6K	● Frío	454 lm/m	29,20 €



Para mejorar la disipación debe utilizarse perfil o pletina de aluminio

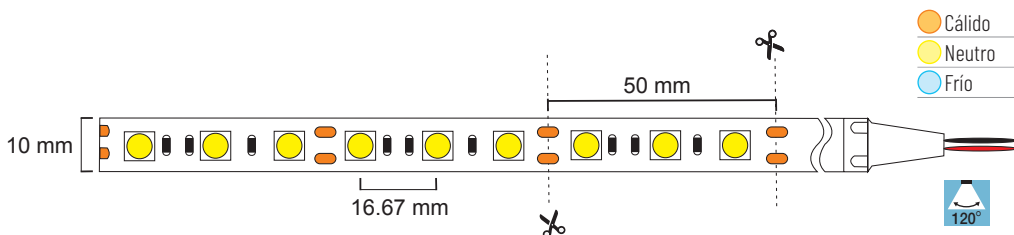

IP20 60 LEDs/metro	T. ^a Color	lm/m	P.V. ● 5 m
12W-IP20-12V-3K	● Cálido	1195 lm/m	37,17 €
12W-IP20-12V-4K	● Neutro	1224 lm/m	37,17 €
12W-IP20-12V-6K	● Frío	1224 lm/m	37,17 €

● IP65 60 LEDs/metro	T. ^a Color	lm/m	P.V. ● 5 m
12W-IP65-12V-3K	● Cálido	1195 lm/m	39,00 €

● IP66 60 LEDs/metro	T. ^a Color	lm/m	P.V. ● 5 m
12W-IP66-12V-3K	● Cálido	1195 lm/m	39,00 €
12W-IP66-12V-6K	● Frío	1224 lm/m	39,00 €



Para mejorar la disipación debe utilizarse perfil o pletina de aluminio

07. TIRAS LED

CONALUX LED

RGB

SMD 12V



 RGB	Rojo	4,2W	97lm
	Verde	4,2W	246lm
	Azul	4,2W	42lm
	Mixto	12W	432lm

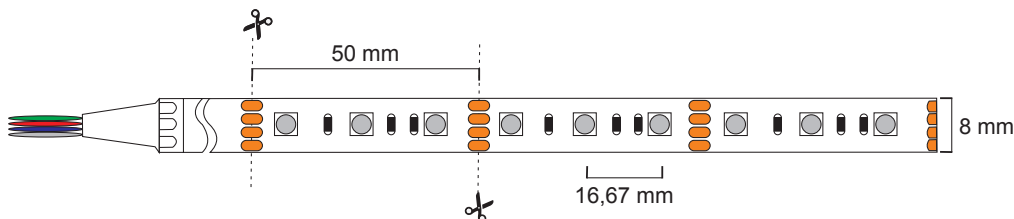

IP20 60 LEDs/metro	T. ^a Color	P.V. ● 5 m
RGB-12W-IP20-12V	 RGB	36,20 €

 IP65 60 LEDs/metro	T. ^a Color	P.V. ● 5 m
RGB-12W-IP65-12V	 RGB	47,20 €



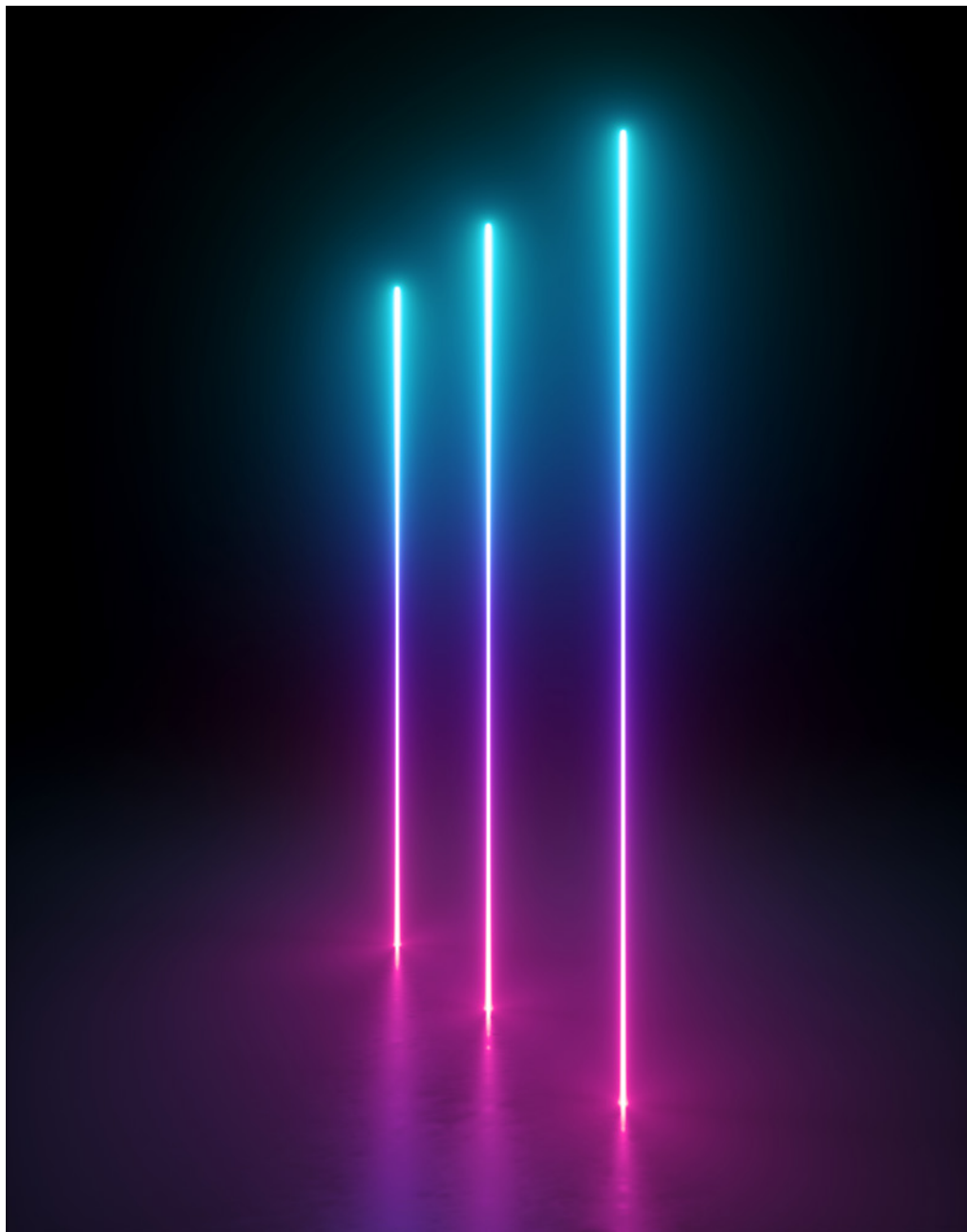

NEÓN

07. TIRAS LED

CONALUX LED

NEÓN 1 - 24V

IP 67 **CRI >80** **24V** **3 AÑOS DE GARANTÍA** **CE** **RoHS** **MacAdam 3-STEP**

- 1700K ■ RGB
- 2700K ■ RGB + ● Frío
- Cálido ■ RGB + ● Cálido
- Neutro ■ PÍXEL
- Frío COB + CDC ● ● ●
- Rojo ■ COB PÍXEL
- Verde
- Azul
- Rosa

- Perfil flexible silicona IP67
- Iluminación frontal

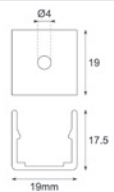
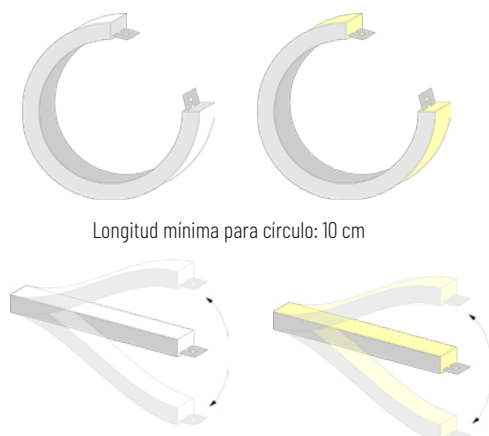
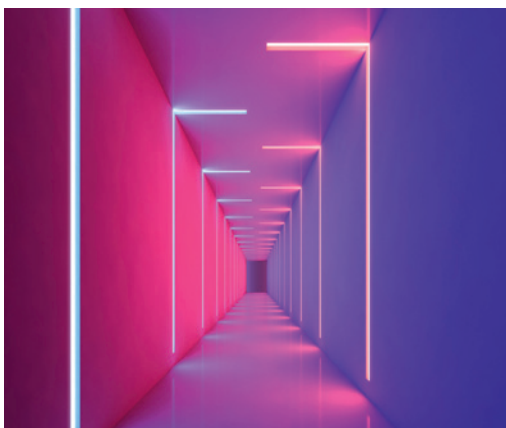
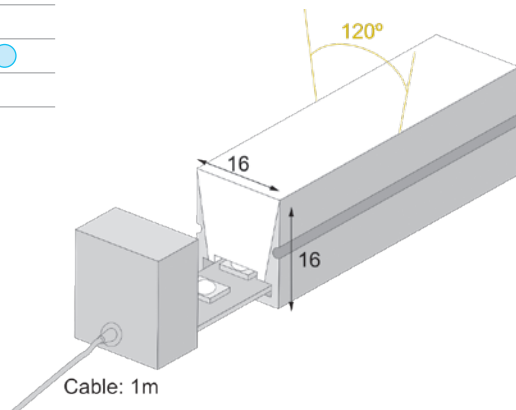

Ref. **GRAPAS NEON1** P.V. **0,64 €**



Ref. **PERFIL FLEX.NEON1** P.V. 1m **8,94 €**



- Perfil flexible silicona IP67
- Iluminación frontal

- 1700K
 - 2700K
 - Cálido
 - Neutro
 - Frío
 - Rojo
 - Verde
 - Azul
 - Rosa
- RGB
 - RGB + Frío
 - RGB + Cálido
 - PÍXEL
 - COB + CDC
 - COB PÍXEL

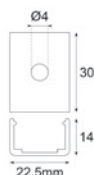
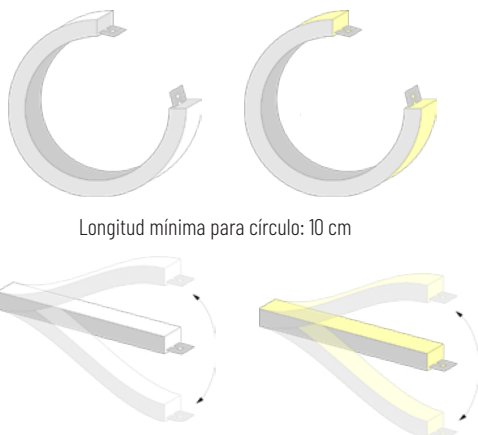
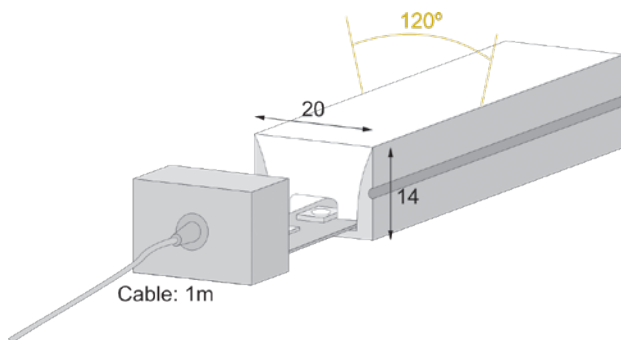

Ref. GRAPAS NEON2 P.V. 0,64 €



Ref. PERFIL FLEX.NEON2 P.V. 1m 8,94 €

07. TIRAS LED

CONALUX LED

NEÓN 3 - 24V

IP 67 **CRI >80** **24V** **3 AÑOS DE GARANTÍA** **CE** **RoHS** **MacAdam 3-STEP**

- 1700K ● RGB
- 2700K ● RGB + ● Frío
- Cálido ● RGB + ● Cálido
- Neutro ● PÍXEL
- Frío ● COB + CDC ● ● ●
- Rojo ● COB PÍXEL
- Verde
- Azul
- Rosa



- Perfil flexible silicona IP67
- Iluminación lateral

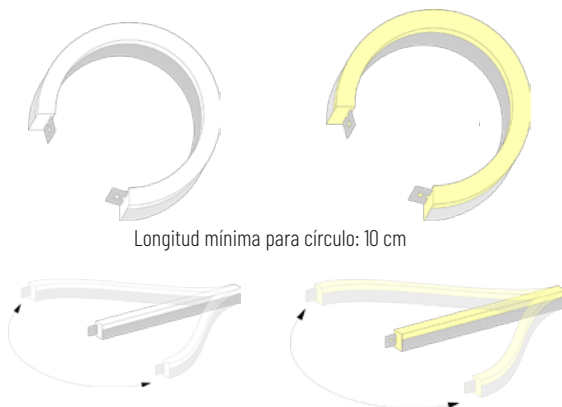
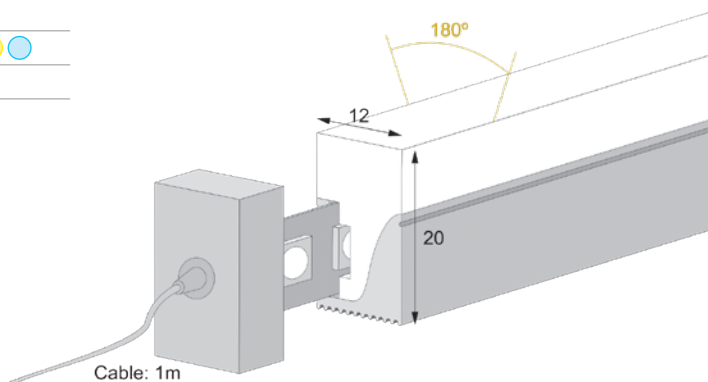

Ref. GRAPAS NEON3 P.V. 0,64 €



Ref. PERFIL FLEX.NEON3 P.V. 1m 8,94 €



- Perfil flexible silicona IP67
- Iluminación lateral

- 1700K
 - 2700K
 - Cálido
 - Neutro
 - Frío
 - Rojo
 - Verde
 - Azul
 - Rosa
- RGB
 - RGB + Frío
 - RGB + Cálido
 - PÍXEL
 - COB + CDC
 - COB PÍXEL

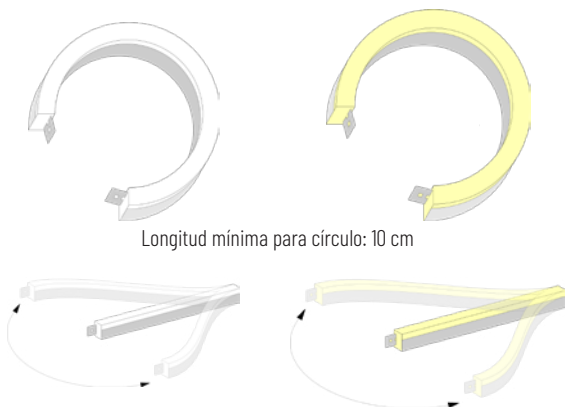
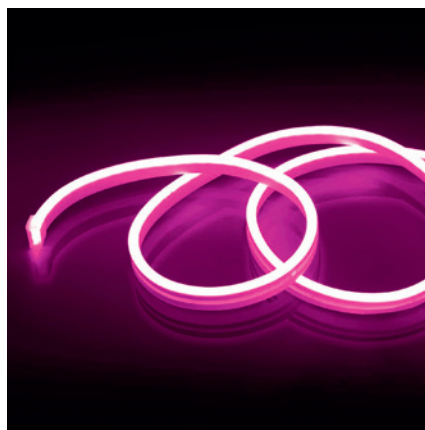
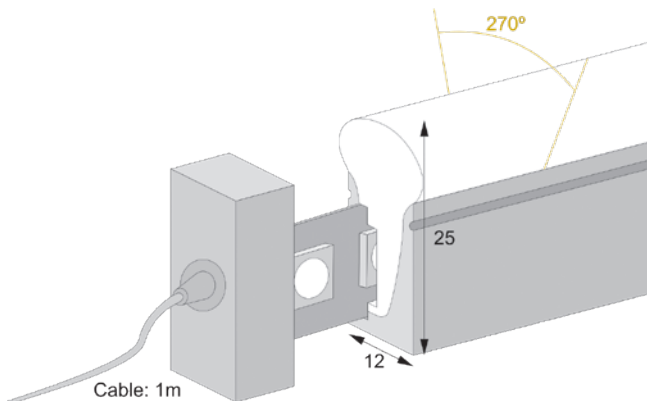

Ref. GRAPAS NEON4 P.V. 0,64 €











Ref. PERFIL FLEX.NEON4 P.V. 1m 8,94 €

TIRAS LED APTAS PARA NEONES 1-2-3-4



- Los precios indicados corresponden a un metro lineal de tira LED
- Se pueden hacer cortes de hasta un máximo de 10 m (consultar según modelo)

24V





12W 60 LEDs/metro	T. ^a Color	lm/m	NEÓN 1	NEÓN 2	NEÓN 3	NEÓN 4
12W-IP67-24V-1700K	 1700K	810 lm/m	28,40 €	28,00 €	28,00 €	28,00 €
12W-IP67-24V-2700K	 2700K	896 lm/m	22,16 €	24,26 €	24,26 €	24,26 €
12W-IP67-24V-3K	 Cálido	896 lm/m	22,16 €	24,26 €	24,26 €	24,26 €
12W-IP67-24V-4K	 Neutro	918 lm/m	22,16 €	24,26 €	24,26 €	24,26 €
12W-IP67-24V-6K	 Frío	918 lm/m	22,16 €	24,26 €	24,26 €	24,26 €
12W-IP67-24V-Rojo	 Rojo	810 lm/m	29,20 €	31,30 €	31,30 €	31,30 €
12W-IP67-24V-Verde	 Verde	810 lm/m	29,20 €	31,30 €	31,30 €	31,30 €
12W-IP67-24V-Azul	 Azul	810 lm/m	29,20 €	31,30 €	31,30 €	31,30 €
12W-IP67-24V-Rosa	 Rosa	810 lm/m	29,20 €	31,30 €	31,30 €	31,30 €

8W 504 LEDs/metro	T. ^a Color	lm/m	NEÓN 1	NEÓN 2	NEÓN 3	NEÓN 4
COB-8W-IP67-24V-3K	 Cálido	600 lm/m	25,60 €	27,90 €	27,90 €	27,90 €
COB-8W-IP67-24V-4K	 Neutro	630 lm/m	25,60 €	27,90 €	27,90 €	27,90 €
COB-8W-IP67-24V-6K	 Frío	660 lm/m	25,60 €	27,90 €	27,90 €	27,90 €

15W 528 LEDs/metro	T. ^a Color	lm/m	NEÓN 1	NEÓN 2	NEÓN 3	NEÓN 4
COB-15W-IP67-24V-3K	 Cálido	1125 lm/m	28,20 €	30,30 €	30,30 €	30,30 €
COB-15W-IP67-24V-4K	 Neutro	1181 lm/m	28,20 €	30,30 €	30,30 €	30,30 €
COB-15W-IP67-24V-6K	 Frío	1237 lm/m	28,20 €	30,30 €	30,30 €	30,30 €

20W 140 LEDs/metro	T. ^a Color	lm/m	NEÓN 1	NEÓN 2	NEÓN 3	NEÓN 4
20W-IP67-24V-3K	 Cálido	1350 lm/m	34,14 €	36,24 €	36,24 €	36,24 €
20W-IP67-24V-4K	 Neutro	1395 lm/m	34,14 €	36,24 €	36,24 €	36,24 €
20W-IP67-24V-5K	 Frío	1395 lm/m	34,14 €	36,24 €	36,24 €	36,24 €

Manipulación: Soldadura + 1 metro de cable 9,40 €

60 LEDs/metro	T. ^a Color	NEÓN 1	NEÓN 2	NEÓN 3	NEÓN 4
12W-IP67-24V-RGB	 RGB	24,50 €	26,70 €	26,70 €	26,70 €
19,2W-IP67-24V-RGB+F	 RGB +  Frío	31,36 €	33,46 €	33,46 €	33,46 €
19,2W-IP67-24V-RGB+C	 RGB +  Cálido	31,36 €	33,46 €	33,46 €	33,46 €

COB 640 a 840 LEDs/m	T. ^a Color	lm/m	NEÓN 1	NEÓN 2	NEÓN 3	NEÓN 4
COB-CDC-16W-IP67-24V	COB + CDC   	1500 lm/m	36,20 €	38,30 €	38,30 €	38,30 €
COB-DIG-14W-IP67-24V	 COB PÍXEL	1500 lm/m	35,40 €	37,50 €	37,50 €	37,50 €

PÍXEL 60 LEDs/metro	T. ^a Color	NEÓN 1	NEÓN 2	NEÓN 3	NEÓN 4
14,4W-IP67-24V-PÍXEL (Digital)	 PÍXEL	28,56 €	30,66 €	30,66 €	30,66 €

Manipulación: Soldadura + 1 metro de cable 13,40 €

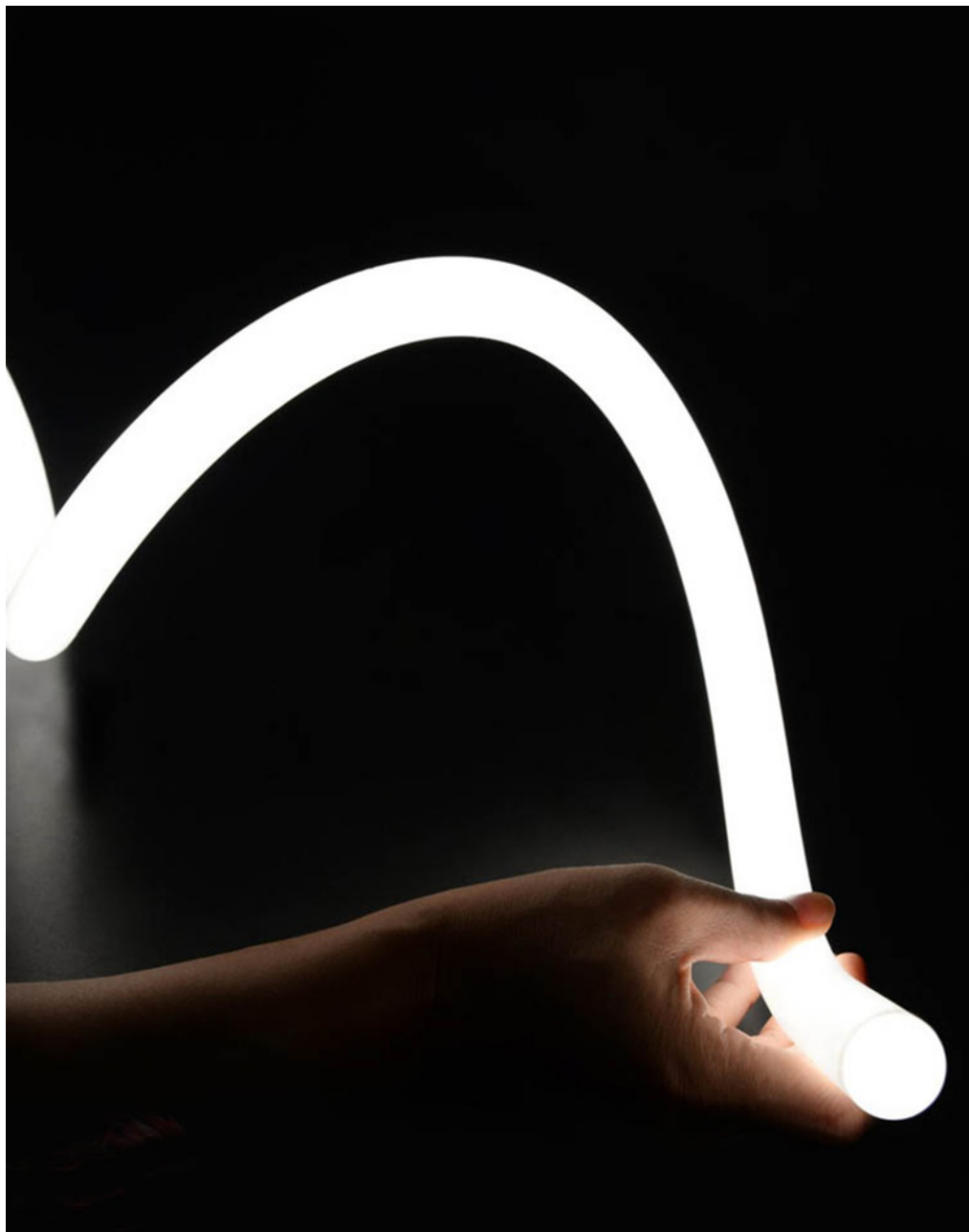

NEÓN 360°

07. TIRAS LED

CONALUX LED

NEÓN FLEXIBLE REDONDO

NEÓN 360°



● Cálido

● Neutro

● Frío

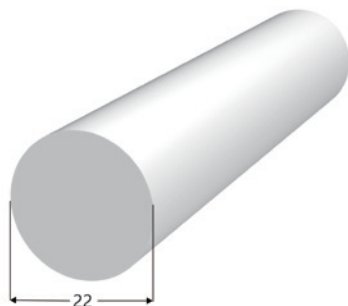

- Neón flexible redondo 360°
- Disponible en acabado blanco mate
- Tapa final metálica blanca
- Diámetro 22 mm
- 20 cm de cable
- Funciona a 24V



240 LEDs/metro	Tª de Color	lm/m	w	P.V.
360-1M-24V	3K, 4K o 5K	2100 lm/m	20 W	27,60 €
360-2M-24V	3K, 4K o 5K	2100 lm/m	40 W	55,20 €
360-3M-24V	3K, 4K o 5K	2100 lm/m	60 W	82,80 €
360-5M-24V	3K, 4K o 5K	2100 lm/m	100 W	138,00 €



ACCESORIOS	Descripción	P.V.
360-AC	Accesorio colgante metálico para Neón 360°	13,40 €
360-AS	Accesorio superficie metálico para Neón 360°	8,60 €
360-GRAPA	Clip-grapa PVC transparente para Neón 360°	0,50 €
360-ASH	Accesorio superficie horizontal para Neón 360°	13,90 €



- Neón colgante horizontal o vertical
- Recubierto de PVC en forma de tubo
- Tapa final metálica cromo

Blanco mate

Cálido

Neutro

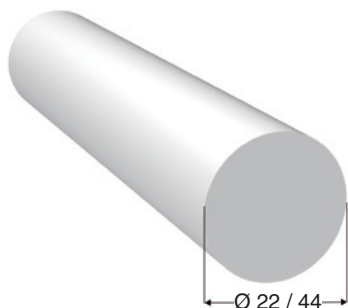

240 LEDs/metro	Ø	Tº de Color	lm/m	w	P.V.
360-H-1M	22 mm	3K o 4K	1500 lm/m	19,2 W	65,00 €
360-V-1M	22 mm	3K o 4K	1500 lm/m	19,2 W	65,00 €
360-XH-1M	44 mm	3K o 4K	1500 lm/m	19,2 W	82,00 €
360-XV-1M	44 mm	3K o 4K	1500 lm/m	19,2 W	82,00 €

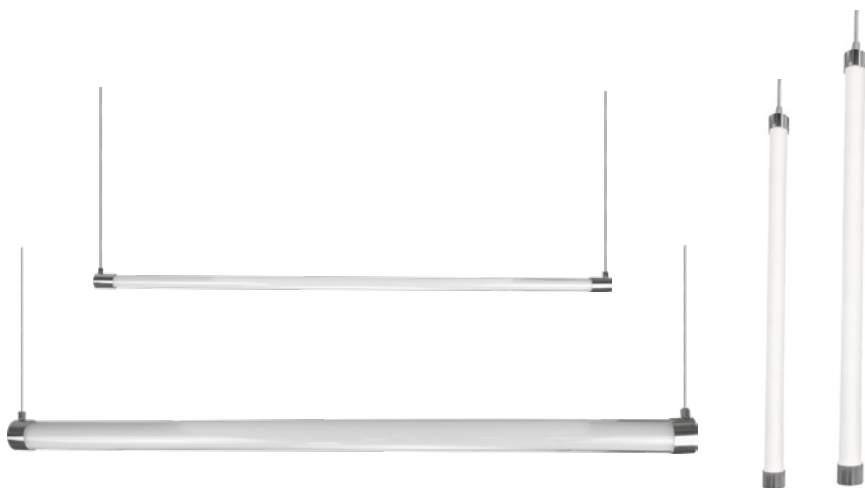

07. TIRAS LED

CONALUX LED

NEÓN EMPOTRAR



01: Blanco

19: Negro

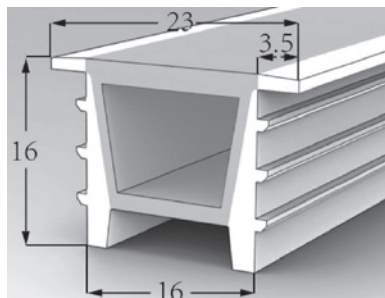

• Neón para empotrar en perfiles de 16 mm o regatas de 16 mm

Ref.	Acabado	P.V. ● 100 m	P.V. ✂ 1m
NEÓN 5 - 01	Blanco	580,00 €	7,10 €
NEÓN 5 - 19	Negro	580,00 €	7,10 €

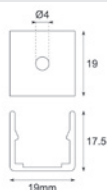

Ref. Grapa neón 5 P.V. 0,64 €



Ref. Perfil flexible neón 5 P.V. 1m 8,94 €



PERFILES

PERFILES PARA SUPERFICIE

Unidad mínima:

Barra de 2m

23: Aluminio



6063 PLETINA LISA DE ALUMINIO

- Se puede utilizar en foseados y lugares donde no se requiera un perfil tapado
- Barra de 2 metros (unidad mínima)

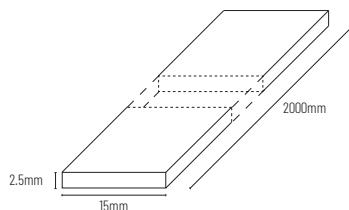

Código	Descripción	Acabado	Longitud	Precio/barra
6063-2m	Pletina Aluminio	Pulido	2000 mm	4,72 €/barra

Unidad mínima:

Barra de 2m

01: Blanco

23: Aluminio



Blanco

Aluminio

H-10, PERFIL PARA SUPERFICIE

- Perfil de extrusión de aluminio
- Para Tiras de LED de 10mm de ancho y máx.14.4W/m
- Disponible difusor Transparente u Opalizado
- Disponibles grapas de fijación
- Barra de 2 metros (unidad mínima)
- Disponible EN ALUMINIO Y BLANCO

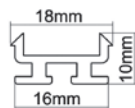
GR10 Grapa de Fijación
35 x 20mm

Código	Descripción	Acabado	Longitud	Precio/barra
H10-2m	Perfil Aluminio	Aluminio	2000 mm	10,40 €/barra
H10-2m-01	Perfil Aluminio	Blanco	2000 mm	12,60 €/barra
DPT10-2m	Difusor Plástico Plano	Transparente	2000 mm	6,90 €/barra
DPO10-2m	Difusor Plástico Plano	Opalizado	2000 mm	6,90 €/barra
GR10	Grapa Fijación	Blanco	35 x 20 mm	0,89 €/unidad

Coste corte de perfil: 5,00 € Coste instalación tira en perfil: 7,00 €

U9 PERFIL PARA SUPERFICIE

- Barra de 2m de perfil de aluminio para superficie
- Aletas cortas
- Válido para montajes de Tiras LED IP20 e IP65

Unidad mínima:
Barra de 2m

23: Aluminio

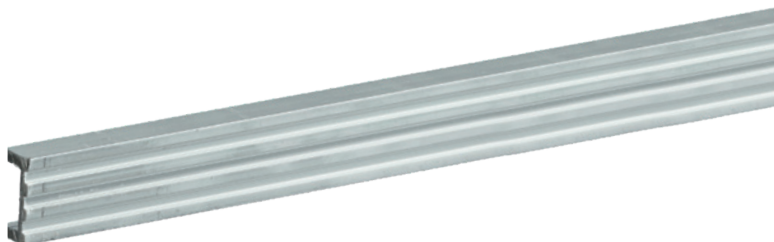
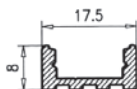

Código	Descripción	Acabado	Longitud	Precio/barra
U9-2m	Perfil Aluminio	Pulido	2000 mm	10,20 €/barra
DPT9-2m	Difusor Plástico Plano	Transparente	2000 mm	6,90 €/barra
DP09-2m	Difusor Plástico Plano	Opalizado	2000 mm	6,90 €/barra
GR9	Grapa Fijación	-	20 x 20 mm	1,06 €/unidad
T9	Tapa Lateral	-	9.3 x 18 mm	0,89 €/unidad

U15 PERFIL PARA SUPERFICIE

- Barra de 2m de perfil de aluminio para superficie
- Aletas altas
- Válido para montajes de Tiras LED, IP20, IP65 e IP66

Unidad mínima:
Barra de 2m

23: Aluminio

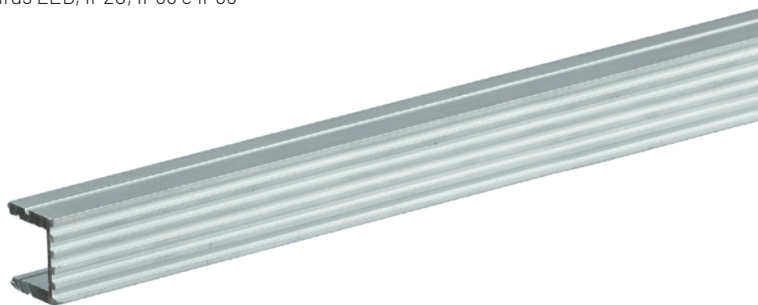
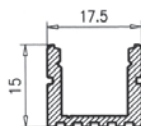

Código	Descripción	Acabado	Longitud	Precio/barra
U15-2m	Perfil Aluminio	Pulido	2000 mm	16,25 €/barra
DPT15-2m	Difusor Plástico Plano	Transparente	2000 mm	6,90 €/barra
DP015-2m	Difusor Plástico Plano	Opalizado	2000 mm	6,90 €/barra
GR15	Grapa Fijación	-	20 x 20 mm	1,06 €/unidad
T15	Tapa Lateral	-	17 x 16 mm	0,89 €/unidad

Coste corte de perfil: 5,00 € Coste instalación tira en perfil: 7,00 €

PERFILES PARA EMPOTRAR

Unidad mínima:

Barra de 2m

23: Aluminio

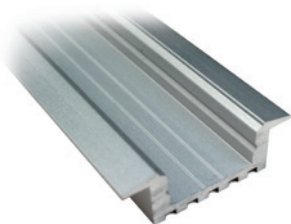

U8E, PERFIL PARA EMPOTRAR

- Perfil de extrusión de aluminio, acabado pulido
- Para Tiras de LED de 10mm de ancho y máx. 14.4W/m
- Disponible difusor Transparente u Opalizado
- Disponibles tapas laterales
- Barra de 2 metros (unidad mínima)

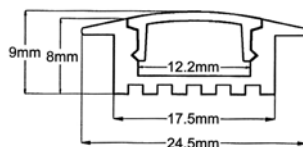

Código	Descripción	Acabado	Longitud	Precio/barra
U8E-2m	Perfil Aluminio	Pulido	2000 mm	10,90 €/barra
DPT8-2m	Difusor Plástico	Transparente	2000 mm	6,90 €/barra
DPO8-2m	Difusor Plástico	Opalizado	2000 mm	6,90 €/barra
T8	Tapa Lateral	Blanco	9.5 x 18mm	0,89 €/unidad

Unidad mínima:

Barra de 2m

23: Aluminio

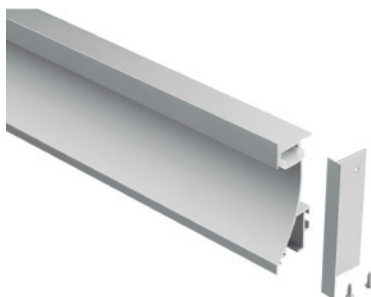

U78E PERFIL PARA EMPOTRAR

- Perfil empotrable bañador de aluminio para iluminación indirecta
- Para señalización o iluminación de escaleras, pasillos y decoración
- Disponible difusor opalizado
- Barra de 2m unidad mínima

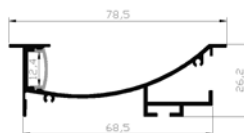

Código	Descripción	Acabado	Longitud	Precio/barra
U78E-2m	Perfil Aluminio	Pulido	2000 mm	56,60 €/barra
DPOU78E-2m	Difusor Plástico Plano	Opalizado	2000 mm	5,60 €/barra
GR78	Grapa Fijación	-	-	1,10 €/unidad
T78	Tapa Lateral	-	80 x 25 mm	0,98 €/unidad

Coste corte de perfil: 5,00 € Coste instalación tira en perfil: 7,00 €

A-19, PERFIL SUPERFICIE PARA ÁNGULO 90°/ESQUINERO

- Perfil de extrusión de aluminio para Tiras de LED de alta luminosidad (SMD 5630 máx. 28W/m)
- Difusor Transparente u Opalizado, opcional

Unidad mínima:
Barra de 2m

23: Aluminio

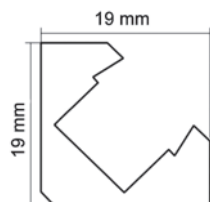

GR19 Grapa de Fijación
35 x 20mm

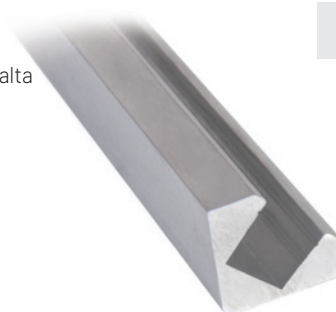

Código	Descripción	Acabado	Longitud	Precio/barra
A19-2m	Perfil Aluminio	Anodizado	2000 mm	24,60 €/barra
DPT19-2m	Difusor Plástico	Transparente	2000 mm	6,90 €/barra
DP019-2m	Difusor Plástico	Opalizado	2000 mm	6,90 €/barra
GR19	Grapa Fijación	Blanco	35 x 20 mm	1,06 €/unidad
T19	Tapa Lateral	Blanco	18.5 x 18.5 mm	0,44 €/unidad

PERFIL V

- Perfil de extrusión de aluminio en forma de V
- Ángulo 90°
- Difusor ovalado

Unidad mínima:
Barra de 2m

23: Aluminio

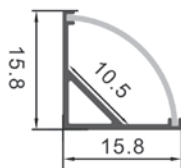

Código	Descripción	Acabado	Longitud	Precio/barra
PerfilV	Perfil Aluminio	Anodizado	2000 mm	4,72 €/barra
DPO V	Difusor Plástico	Opalizado	2000 mm	3,99 €/barra
GR V	Grapa Metálica	Metal		0,42 €/barra
T. V	Tapa Final	Blanco		0,63 €/barra

Coste corte de perfil: 5,00 € Coste instalación tira en perfil: 7,00 €



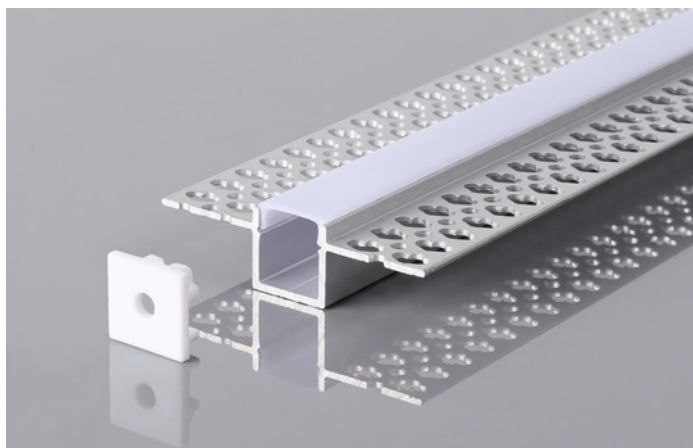

LÍNEAS 1

- PERFIL de extrusión de aluminio PARA EMPOTRAR y hacer líneas rectas
- Perfil para empotrar en escayola para tira LED de hasta 12mm

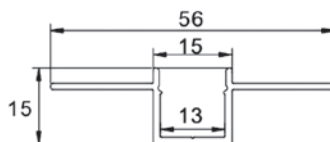

Código	Descripción	Acabado	Longitud	Precio/barra
Líneas 1	Perfil Aluminio	-	2000 mm	17,74 €/barra
DPO Líneas 1	Difusor Plástico	Opalizado	2000 mm	3,99 €/barra
T. Líneas 1	Tapa Final	-		0,63 €/barra

Coste corte de perfil: 5,00 € Coste instalación tira en perfil: 7,00 €



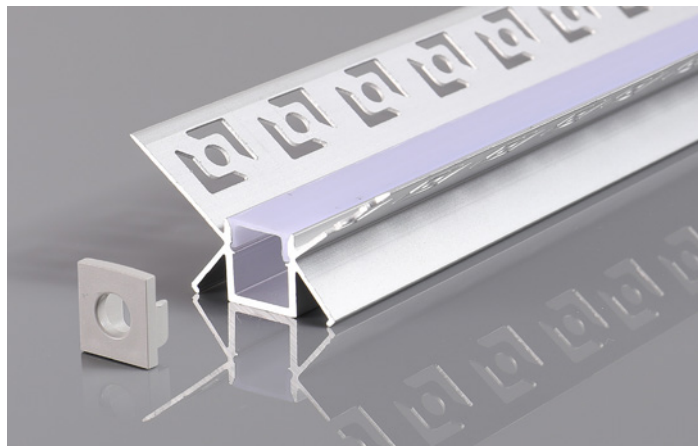

LÍNEAS 2

- Perfil de extrusión de aluminio para empotrar en esquinas interiores
- Perfil para empotrar en escayola para tira LED de hasta 8mm

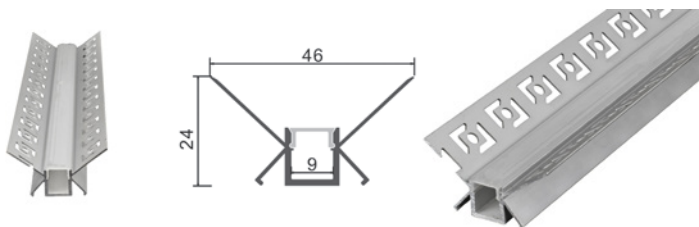

Código	Descripción	Acabado	Longitud	Precio/barra
Líneas 2	Perfil Aluminio	-	2000 mm	17,74 €/barra
DPO Líneas 2	Difusor Plástico	Opalizado	2000 mm	3,99 €/barra
T. Líneas 2	Tapa Final	Gris		0,63 €/barra

Coste corte de perfil: 5,00 € Coste instalación tira en perfil: 7,00 €



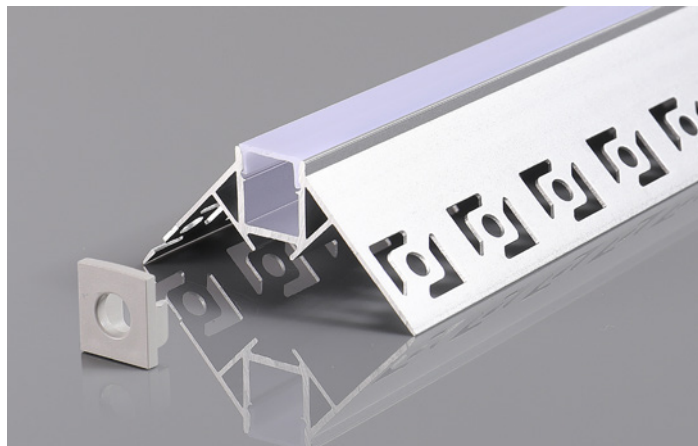

LÍNEAS 3

- Perfil de extrusión de aluminio PARA EMPOTRAR en esquinas exteriores
- Perfil para empotrar en escayola para tira LED de hasta 8mm

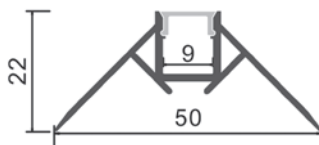

Código	Descripción	Acabado	Longitud	Precio/barra
Líneas 3	Perfil Aluminio	-	2000 mm	18,80 €/barra
DPO Líneas 3	Difusor Plástico	Opalizado	2000 mm	3,99 €/barra
T. Líneas 3	Tapa Final	Gris		0,63 €/barra

Coste corte de perfil: 5,00 € Coste instalación tira en perfil: 7,00 €



■ 19: Negro



PERFIL MUEBLES

- PERFIL de extrusión de aluminio para iluminar muebles, repisas, estanterías, etc.
- Recomendado para tira LED ultrafina

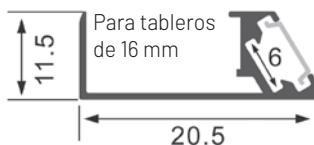

Código	Descripción	Acabado	Longitud	Precio/barra
Perfil Muebles	Perfil Aluminio	Negro	2000 mm	19,90 €/barra
DPO Muebles	Difusor Plástico	Opalizado	2000 mm	3,66 €/barra
T. Muebles	Tapa Final	Gris		0,42 €/barra

Coste corte de perfil: 5,00 € Coste instalación tira en perfil: 7,00 €



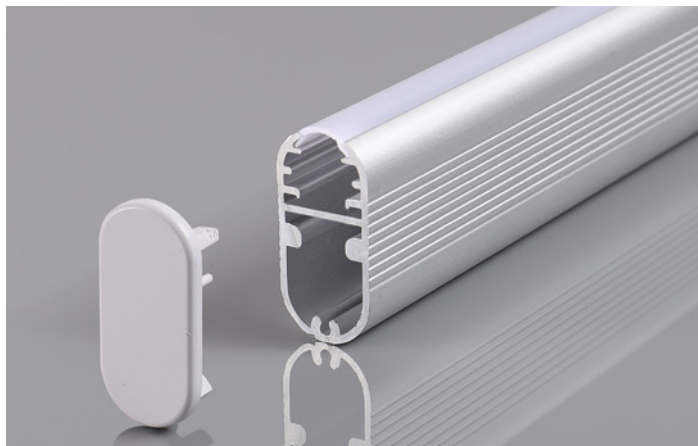

PERFIL PERCHERO

- Barra de extrusión de aluminio, con cavidad para incrustar tira de LED
- Válida para cualquier tipo de tira LED

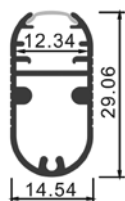
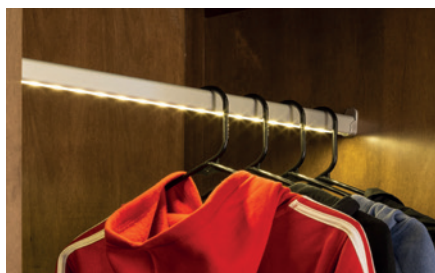

Código	Descripción	Acabado	Longitud	Precio/barra
Perfil Perchero	Perfil Aluminio	-	2000 mm	29,40 €/barra
DPO Perchero	Difusor Plástico	Opalizado	2000 mm	3,99 €/barra
T. Perchero	Tapa Final	Blanco		0,94 €/barra
Gancho Perchero	Gancho	Metal		3,78 €/barra

Coste corte de perfil: 5,00 € Coste instalación tira en perfil: 7,00 €





PERFIL AÉREO

Perfil aéreo de aluminio, perfecto para situaciones donde no tenemos un lugar físico para colocar la iluminación. Crea diferentes ambientes lumínicos sin necesidad de hacer obra. Consta de dos tensores (para colocar en paredes/techos), y 10 metros de perfil de aluminio con los que crearemos nuestro ambiente, más accesorios para su instalación.

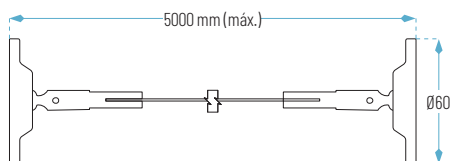

Código	Descripción	Acabado	Longitud	Precio/kit
Perfil Aéreo	Perfil Aluminio	Níquel	5 m	124,20 €/kit

PERFILES PARA EMPOTRAR

Unidad mínima:

Barra de 2m

Perfil	Difusor
<input type="checkbox"/> 01: Blanco	<input type="checkbox"/> 0: Opalizado
<input checked="" type="checkbox"/> 19: Negro	<input checked="" type="checkbox"/> 19: Negro
<input checked="" type="checkbox"/> 23: Aluminio	

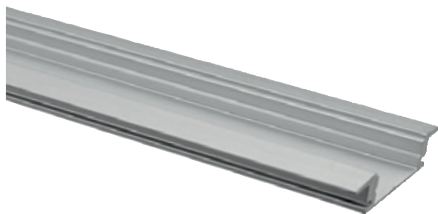

U7E, PERFIL PARA EMPOTRAR

- Perfil de extrusión de aluminio acabado blanco, negro o aluminio
- Disponible difusor negro u opalizado
- Disponibles tapas laterales
- Barra de 2m (unidad mínima)

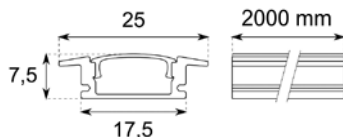

Código	Descripción	Acabado	Longitud	Precio/barra
U7E-2M	Perfil Aluminio	Blanco, Negro o Aluminio	2000 mm	7,40 €/barra
DPT7-2M-19	Difusor Plástico	Negro	2000 mm	3,70 €/barra
DP07-2m	Difusor Plástico	Opalizado	2000 mm	3,70 €/barra
T7	Tapa Lateral	Blanco o negro	-	0,42 €/unidad

Unidad mínima:

Barra de 2m

<input type="checkbox"/> 01: Blanco	<input type="checkbox"/> 0: Opalizado
<input checked="" type="checkbox"/> 19: Negro	<input checked="" type="checkbox"/> 19: Negro



U16, PERFIL PARA SUPERFICIE

- Perfil de extrusión de aluminio acabado en blanco o en negro
- Disponible difusor negro u opalizado
- Barra de 2m (unidad mínima)

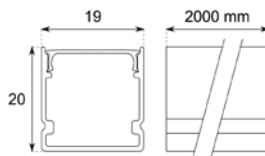

Código	Descripción	Acabado	Longitud	Precio/barra
U16-2m	Perfil Aluminio	Blanco o Negro	2000 mm	10,40 €/barra
DPO16-2m	Difusor Plástico	Opalizado	2000 mm	3,70 €/barra
DP16-2m-19	Difusor Plástico	Negro	2000 mm	3,70 €/barra
GR16	Grapa Fijación	-	-	0,42 €/unidad
T16	Tapa Lateral	Blanco o Negro	-	0,42 €/unidad

Coste corte de perfil: 5,00 € Coste instalación tira en perfil: 7,00 €



PERFILES RÍGIDOS ESTANCOS

07. TIRAS LED

CONALUX LED

IP40 24V

PERFILES RÍGIDOS ESTANCOS



OPCIONES WiFi™

Cálido

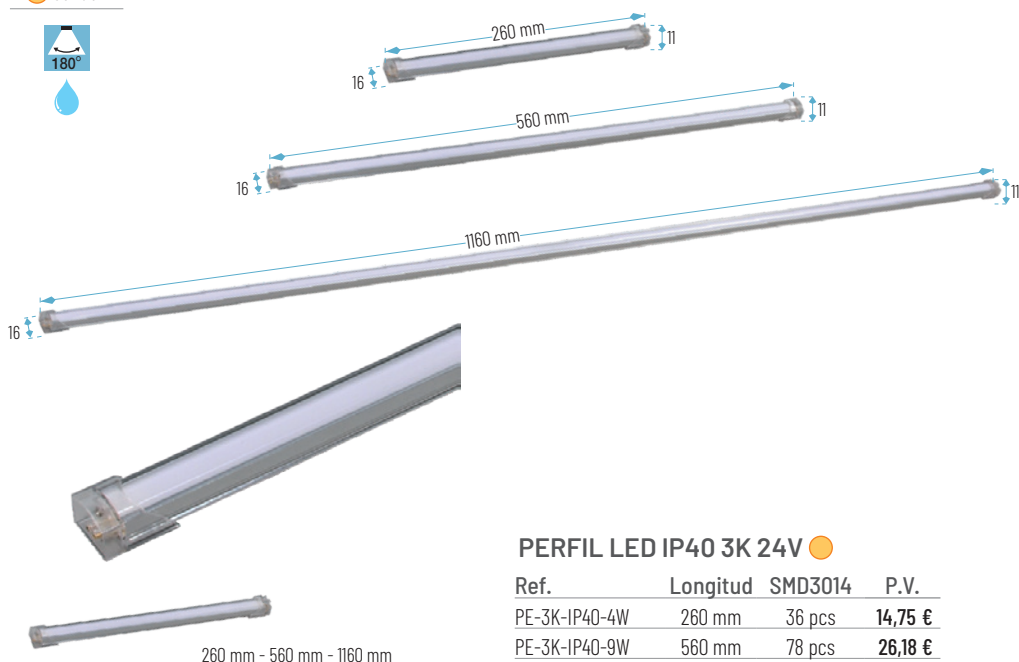

260 mm - 560 mm - 1160 mm

PERFIL LED IP40 3K 24V

Ref.	Longitud	SMD3014	P.V.
PE-3K-IP40-4W	260 mm	36 pcs	14,75 €
PE-3K-IP40-9W	560 mm	78 pcs	26,18 €
PE-3K-IP40-18W	1160 mm	162 pcs	49,28 €

Cable con conector de entrada de alimentación DC al perfil IP40



Ref.	P.V.
CC-PE-IP40-200 mm	6,59 €
CC-PE-IP40-300 mm	7,10 €
CC-PE-IP40-500 mm	8,14 €
CC-PE-IP40-1000 mm	9,13 €

Cable con conectores Macho y Hembra para interconexiones de perfiles IP40



Ref.	P.V.
CE-PE-IP40-200 mm	5,99 €
CE-PE-IP40-300 mm	6,46 €
CE-PE-IP40-500 mm	7,40 €
CE-PE-IP40-1000 mm	8,30 €

Kit de 2 grapas metálicas orientables (rotación 180°) para perfil LED IP40 / IP64. Posibilidad de fijación con imán incorporado o por tornillo en orificio integrado.



Ref.	P.V.
KIT-GR-PE-IP40/IP64	10,68 € (2 uds)

OPCIONES



● Cálido

● Frío

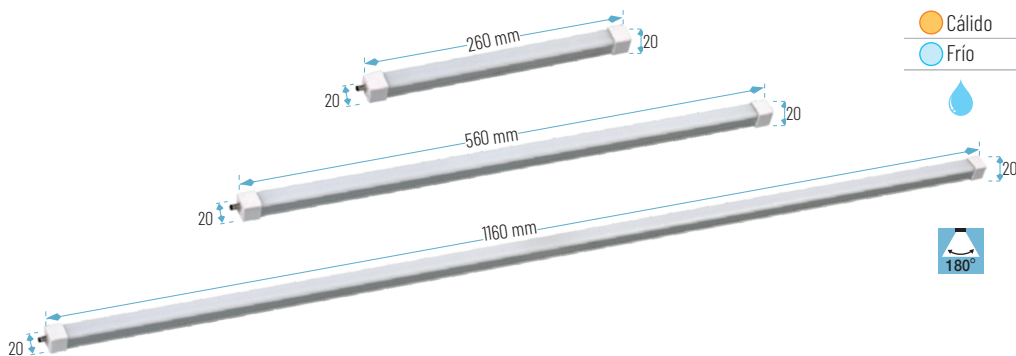

PERFIL LED IP64 6K 24V ●
4W / 9W / 18W

Ref.	Longitud	SMD2016	P.V.
PE-6K-IP64-4W	260 mm	36 pcs	16,06 €
PE-6K-IP64-9W	560 mm	78 pcs	28,05 €
PE-6K-IP64-18W	1160 mm	162 pcs	54,90 €

PERFIL LED IP64 3K 24V ●
4W / 9W / 18W

Ref.	Longitud	SMD2016	P.V.
PE-3K-IP64-4W	260 mm	36 pcs	16,06 €
PE-3K-IP64-9W	560 mm	78 pcs	28,05 €
PE-3K-IP64-18W	1160 mm	162 pcs	54,90 €

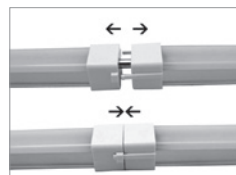

Grapas de fijación
(ver en página anterior)

Cable con conector de entrada de alimentación DC al perfil LED IP64



Ref.	P.V.
CC-PE-IP64-200 mm	1,84 €
CC-PE-IP64-500 mm	3,23 €
CC-PE-IP64-1000 mm	4,16 €

Cable con conectores Macho y Hembra para interconexiones de perfiles LED IP64



Ref.	P.V.
CE-PE-IP64-200 mm	1,84 €
CE-PE-IP64-500 mm	3,24 €
CE-PE-IP64-1000 mm	4,16 €

Cable derivación en Y para perfil LED IP64. (1 Entrada- 2 Salidas)
Entrada 500 mm
Salida 2000 mm



Ref.	P.V.
CY-PE-IP64-500-2000 mm	10,16 €



MÓDULOS CARTELERÍA



Frío



MLED4-1.44W-12V5K

- Módulo de LED IP65, 4 LEDs 1.44W alimentación 12 VDC
- LED SMD Epistar 2835 140lm Módulo
- Conjunto 13 módulos (18,72W en total)
- 2,5 m de longitud total, longitud de cable entre módulos 17 cm, separación entre módulos 21 cm de centro a centro
- PCB de Aluminio, Cinta 3M doble cara
- Ver fuentes de alimentación desde página 710

Lúmenes aplicación: 1,44W: 140 lm

Ref.	P.V.
MLED4-1.44W-12V5K	27,94 €

RESULTADOS FOTOMÉTRICOS
para la referencia MLED4-1.44W-12V5K

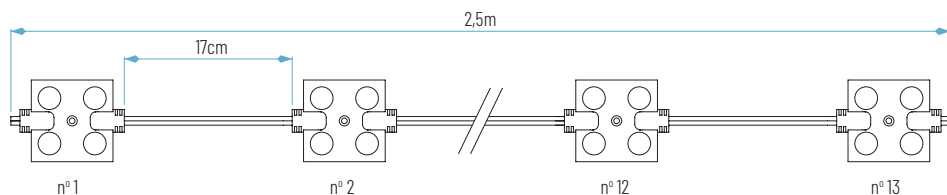
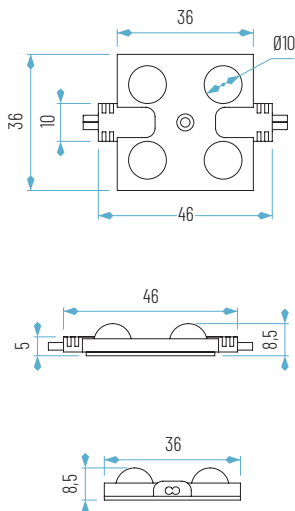
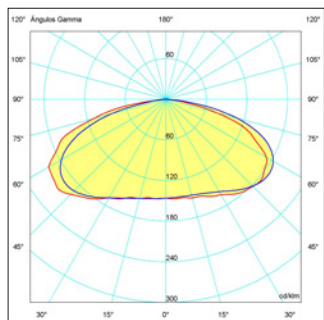



MLED2-0.72W-12V5K

- Módulo de LED IP65, 2 LEDs 0.72W alimentación 12 VDC
- LED SMD Epistar 2835 70lm Módulo
- Conjunto 20 módulos unidos (14,4W en total)
- 2,65 m de longitud total, longitud de cable entre módulos 8,5 cm
- Cinta 3M doble cara
- Ver fuentes de alimentación desde página 710

Frio



Lúmenes aplicación: 0,72W: 70 lm

Ref.	P.V.
MLED2-0.72W-12V5K	22,88 €

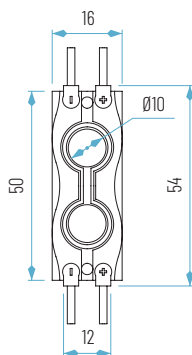
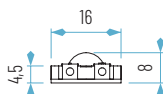
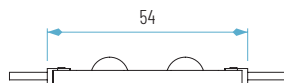

RESULTADOS FOTOMÉTRICOS
para la referencia MLED2-0.72W-12V5K

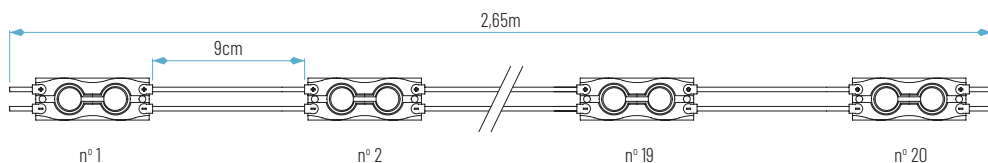
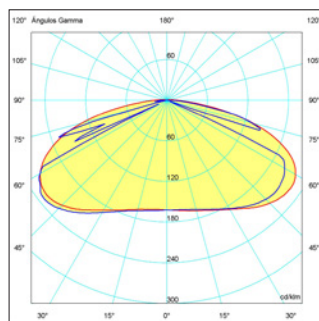



Frio

**MLED3-1.08W-12V5K**

- Módulo de LED IP65, 3 LEDs 1.08W alimentación 12 VDC
- LED SMD Epistar 2835 105lm Módulo
- Conjunto 20 módulos unidos (21,6W en total)
- 3 m de longitud total, longitud de cable entre módulos 9 cm
- Cinta 3M doble cara
- Ver fuentes de alimentación desde página 710

Lúmenes aplicación: 1,08W: 105 lm

Ref.	P.V.
MLED3-1.08W-12V5K	23,98 €

RESULTADOS FOTOMÉTRICOS

para la referencia MLED3-1.08W-12V5K

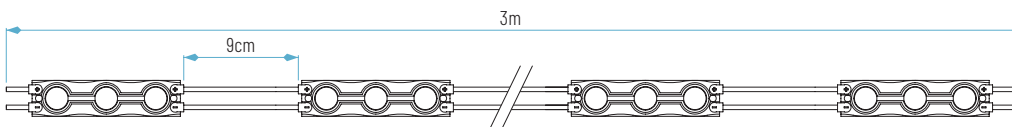
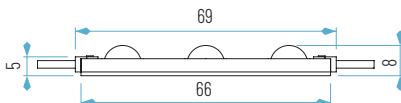
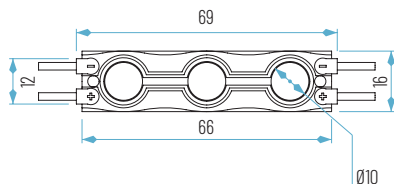
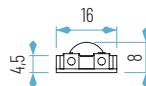
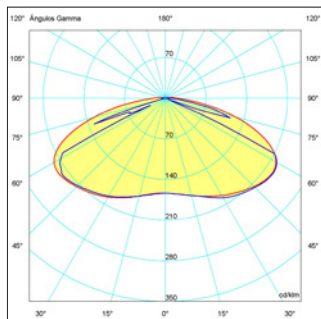



MLED1-4W-12V6K

- Módulo de LED IP65, 1 LEDs 4W alimentación 12 VDC
- LED Epistar 2835 275lm Módulo
- Conjunto 15 módulos unidos (60W en total)
- 4,6 m de longitud total, longitud de cable entre módulos 23 cm
- PCB de Aluminio+Disipador de Aluminio, Cinta 3M doble cara
- Ver fuentes de alimentación desde página 710

Frio



Lúmenes aplicación: 4W: 275 lm

Ref.	P.V.
MLED1-4W-12V6K	126,22 €

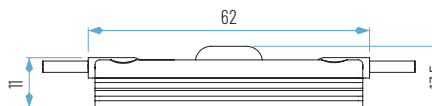
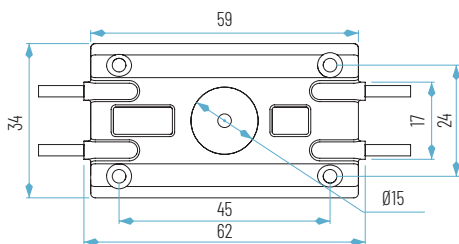
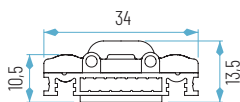

RESULTADOS FOTOMÉTRICOS
para la referencia MLED1-4W-12V6K

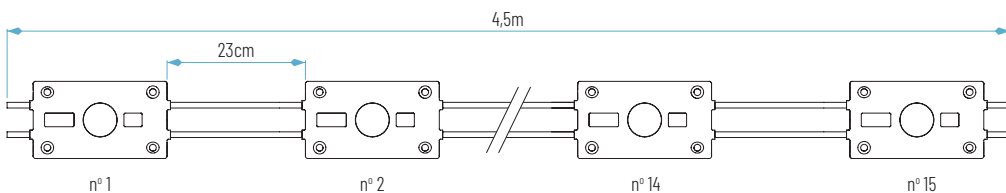
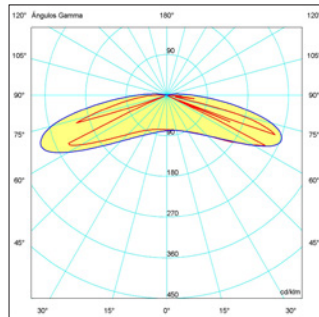



Frío



MLED1-2.2W-12V5K

- Módulo de LED IP65, 1 LEDs 2.2W alimentación 12 VDC
- LED SAMSUNG 200lm Módulo
- Conjunto 30 módulos unidos (66W en total)
- 3,8 m de longitud total, longitud de cable entre módulos 9 cm
- Corte cada 3 unidades
- Cinta 3M doble cara
- Ver fuentes de alimentación desde página 710

Lúmenes aplicación: 2,2W: 200 lm

Ref.	P.V.
MLED1-2.2W-12V5K	138,06 €

RESULTADOS FOTOMÉTRICOS

para la referencia MLED1-2.2W-12V5K

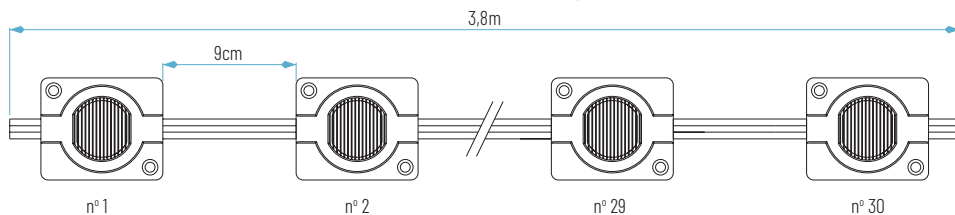
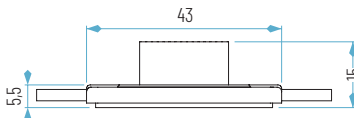
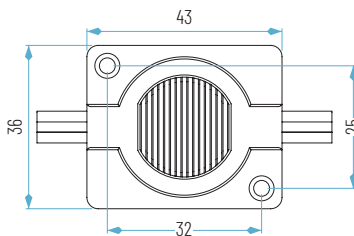
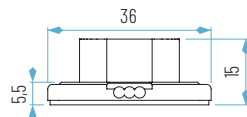
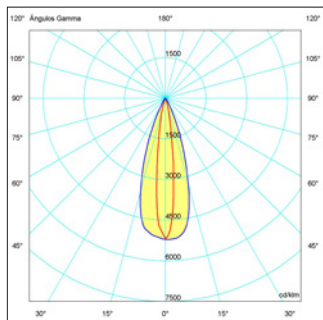



MLED4-1.44W-12VRGB

- Módulo de LED IP65, 4 LEDs 1.44W alimentación 12 VDC
- 4xSMD 5050 RGB LED
- Conjunto 20 módulos unidos (28,8W en total)
- 2,4 m de longitud total, longitud de cable entre módulos 7 cm
- Cinta 3M doble cara
- Ver fuentes de alimentación desde página 710

RGB



Ref.	P.V.
MLED4-1.44W-12VRGB	39,16 €

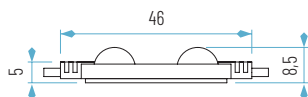
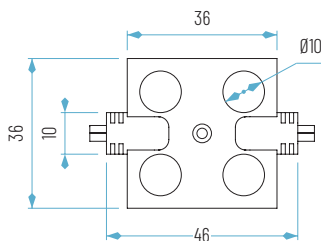
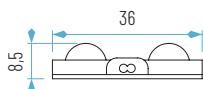

RESULTADOS FOTOMÉTRICOS

para la referencia MLED4-1.44W-12VRGB

