





















01. EMPOTRAR - DOWNLIGHTS

ÍNDICE VISUAL

  <p>  1001 DOWNLIGHT UNIVERSAL Pg. 130 </p>	 <p>  5093-18W Pg. 131 </p>	 <p>  5092 6W Pg. 132 </p>	 <p>  5092 12W Pg. 132 </p>	 <p>  5092 20W Pg. 132 </p>
 <p>  5092 30W Pg. 132 </p>	 <p>  5093 6W Pg. 133 </p>	 <p>  5093 12W Pg. 133 </p>	 <p>  5093 20W Pg. 133 </p>	 <p>  5093 30W Pg. 133 </p>
 <p>  5094 6W Pg. 134 </p>	 <p>  5094 12W Pg. 134 </p>	 <p>  5094 20W Pg. 134 </p>	 <p>  5094 30W Pg. 134 </p>	 <p>  5095 6W Pg. 135 </p>
 <p>  5095 12W Pg. 135 </p>	 <p>  5095 20W Pg. 135 </p>	 <p>  5095 30W Pg. 135 </p>	 <p>  5090 Pg. 136 </p>	 <p>  5091 Pg. 136 </p>
  <p>  5064 7W Pg. 137 </p>	  <p>  5064 12W Pg. 137 </p>	  <p>  5064 25W Pg. 137 </p>	  <p>  5067 7W Pg. 138 </p>	  <p>  5067 15W Pg. 138 </p>

  <p>5067 25W Pg. 138</p>	 <p>5086 6W Pg. 139</p>	 <p>5086 12W Pg. 139</p>	 <p>5086 20W Pg. 139</p>	 <p>5087 6W Pg. 140</p>
 <p>5087 12W Pg. 140</p>	 <p>5087 20W Pg. 140</p>	 <p>5065 Pg. 141</p>	 <p>5099 GALAXY 12W Pg. 142</p>	 <p>5099 GALAXY 24W Pg. 142</p>
 <p>5068 7W Pg. 143</p>	 <p>5068 15W Pg. 143</p>	 <p>5068 25W Pg. 144</p>	 <p>5068 40W Pg. 144</p>	  <p>5062 7W Pg. 147</p>
  <p>5062 30W Pg. 147</p>				



Ø230 mm
Ø65 - Ø205 mm (variable)

OPCIONES **WiFi** **REG** **E**

□ 01: Blanco

CDC ● ● ●

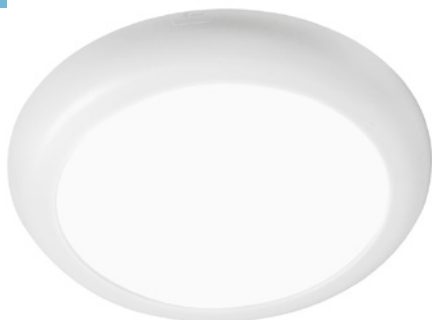

1001 DOWNLIGHT UNIVERSAL

Ref.	Acabado	P.V.
1001	Blanco	33,60 €

Lúmenes chip:
1001-10W: 1037 lm
1001-15W: 1556 lm
1001-18W: 1868 lm



Selector de potencia (10W-15W-18W)
Selector de temperaturas (3K-4K-6K)

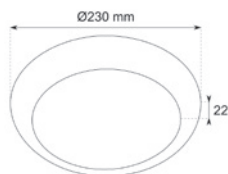

RESULTADOS FOTOMÉTRICOS para la referencia 1001

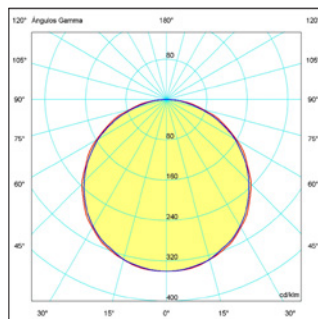

Ø230 x H22 mm
Ø65-205 mm (variable)



5093-18W CDC 3K-6K

Lúmenes chip: 5093-18W: 2100 lm
Lúmenes aplicación: 5093-18W: 1800 lm

01: Blanco

CDC



Ref.	P.V.
5093-01-18W-CDC	79,38 €
Mando 5093-18W CDC	10,00 €



Funciona con nuestra App

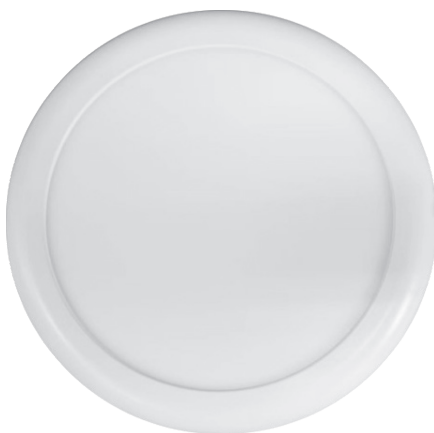

Control RF



PANELES LED EMPOTRAR 5092



- 01: Blanco
- 02: Níquel
- 04: Titanio
- 19: Negro
- Cálido
- Neutro
- Frío

5092/6W, 12W y 20W



5092-01-6W
120 x 120 x 25 mm
105 x 105 mm

Lúmenes chip:
5092-6W: 525 lm
Lúmenes aplicación:
5092-6W: 450 lm

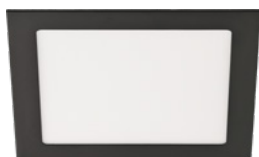

5092-19-12W
172 x 172 x 25 mm
150 x 150 mm

Lúmenes chip:
5092-12W: 1050 lm
Lúmenes aplicación:
5092-12W: 940 lm

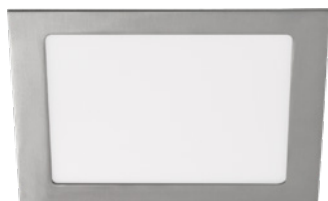

5092-02-20W
225 x 225 x 25 mm
205 x 205 mm

Lúmenes chip:
5092-20W: 1900 lm
Lúmenes aplicación:
5092-20W: 1500 lm

- 01: Blanco
- Cálido
- Neutro

5092/30W



5092-01-30W
294 x 294 mm
280 x 280 mm

Lúmenes chip:
5092-30W: 3050 lm
Lúmenes aplicación:
5092-30W: 2550 lm



Ref.	Acabado	6W	12W	20W	30W
5092-01	Blanco	11,02 €	14,59 €	16,70 €	34,20 €
5092-02	Níquel	13,22 €	17,50 €	20,04 €	-
5092-04	Titanio	11,97 €	15,54 €	17,65 €	-
5092-19	Negro	13,22 €	17,50 €	20,04 €	-
Opción multiencendido +		+6 €	+7,60 €	+9,60 €	+11,80 €

OPCIONES **12V/24V** **WiFi** **REG** **E**

Flicker Free **RoHS** **IP 20** **FP >0.9** **CRI >80**

5093/6W, 12W y 20W

- 01: Blanco
- 02: Níquel
- 04: Titanio
- 19: Negro
- Cálido
- Neutro
- Frío

Lúmenes chip:
5093-6W: 525 lm
Lúmenes aplicación:
5093-6W: 450 lm

5093-01-6W
Ø120 x 25 mm
Ø105 mm



Lúmenes chip:
5093-12W: 1050 lm
Lúmenes aplicación:
5093-12W: 940 lm

5093-19-12W
Ø172 x 25 mm
Ø160 mm



Lúmenes chip:
5093-20W: 1900 lm
Lúmenes aplicación:
5093-20W: 1500 lm

5093-04-20W
Ø225 x 25 mm
Ø205 mm



5093/30W

Lúmenes chip:
5093-30W: 3050 lm
Lúmenes aplicación:
5093-30W: 2550 lm

5093-01-30W
Ø297 x 24 mm
Ø284 mm



- 01: Blanco
- Cálido
- Neutro
- Frío



Ref.	Acabado	6W	12W	20W	30W
5093-01	Blanco	11,02 €	14,59 €	16,70 €	34,20 €
5093-02	Níquel	13,22 €	17,50 €	20,04 €	-
5093-04	Titanio	11,97 €	15,54 €	17,65 €	-
5093-19	Negro	13,22 €	17,50 €	20,04 €	-
Opción multiencendido +		+6 €	+7,60 €	+9,60 €	+11,80 €



 01: Blanco

 04: Titanio

 19: Negro

 Cálido

 Neutro

 Frío

5094/6W, 12W y 20W



5094-01-6W
120 x 120 x 35 mm

Lúmenes chip:
5094-6W: 525 lm
Lúmenes aplicación:
5094-6W: 450 lm



5094-19-12W
170 x 170 x 35 mm

Lúmenes chip:
5094-12W: 1050 lm
Lúmenes aplicación:
5094-12W: 940 lm



5094-04-20W
225 x 225 x 35 mm

Lúmenes chip:
5094-20W: 1900 lm
Lúmenes aplicación:
5094-20W: 1500 lm

 01: Blanco

 Cálido

 Neutro

5094/30W



5094-01-30W
300 x 300 mm

Lúmenes chip:
5094-30W: 3050 lm
Lúmenes aplicación:
5094-30W: 2550 lm



Ref.	Acabado	6W	12W	20W	30W
5094-01	Blanco	13,54 €	16,69 €	20,89 €	38,25 €
5094-04	Titanio	14,70 €	18,50 €	22,05 €	-
5094-19	Negro	16,25 €	20,02 €	25,06 €	-
Opción multiencendido +		+6 €	+7,60 €	+9,60 €	+11,80 €

OPCIONES **12V/24V** **WiFi** **REG** **E**

Flicker Free **RoHS** **CE** **IP 20** **FP >0.9** **CRI >80**

5095/6W, 12W, 20W y 30W

- 01: Blanco
- 04: Titanio
- 19: Negro
- Cálido
- Neutro
- Frio



Lúmenes chip:
5095-6W: 525 lm
Lúmenes aplicación:
5095-6W: 450 lm

5095-01-6W
Ø120 x 35 mm



Lúmenes chip:
5095-12W: 1050 lm
Lúmenes aplicación:
5095-12W: 940 lm

5095-19-12W
Ø170 x 35 mm



Lúmenes chip:
5095-20W: 1900 lm
Lúmenes aplicación:
5095-20W: 1500 lm

5095-04-20W
Ø225 x 35 mm



5095/30W

- 01: Blanco
- Cálido
- Neutro



Lúmenes chip:
5095-30W: 3050 lm
Lúmenes aplicación:
5095-30W: 2550 lm

5095-01-30W
Ø300 x 38 mm



Ref.	Acabado	6W	12W	20W	30W
5095-01	Blanco	13,54 €	16,69 €	20,89 €	38,25 €
5095-04	Titanio	14,70 €	18,50 €	22,05 €	-
5095-19	Negro	16,25 €	20,02 €	25,06 €	-
Opción multiencendido +		+6 €	+7,60 €	+9,60 €	+11,80 €



DOWNLIGHTS LED SMD



220 x 220 x 55 mm
180 x 180 mm

OPCIONES **12V/24V** **WiFi** **REG** **E**

01: Blanco

04: Titanio

Neutro

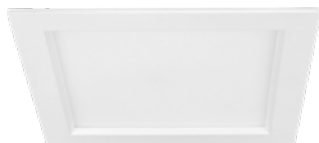

5090-01-25W



5090-04-25W

5090-25W

Lúmenes chip: 5090-25W: 2600 lm
Lúmenes aplicación: 5090-25W: 2150 lm

Ref.	P.V.
5090-01-25W 4200K	40,20 €
5090-04-25W 4200K	40,20 €

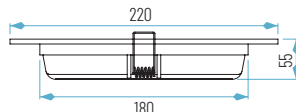
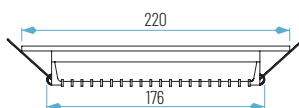

Ø230 x 33 mm
Ø190 mm

OPCIONES **12V/24V** **WiFi** **REG** **E**

01: Blanco

04: Titanio

Cálido

Neutro

Neutro



5091-01-25W



5091-04-25W

5091-25W

Lúmenes chip: 5091-25W: 2600 lm
Lúmenes aplicación: 5091-25W: 2150 lm

Ref.	P.V.
5091-01-25W 3000K o 4200K	40,20 €
5091-04-25W 4200K	40,20 €

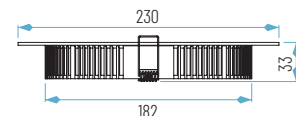
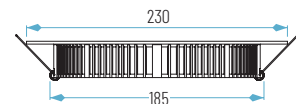
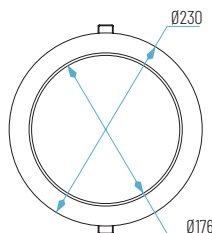

OPCIONES **WiFi** **E**

Ø96 x 57 mm
Ø70 mm



5064-01-7W

01: Blanco

Neutro



Lúmenes chip: 5064-7W: 680 lm
Lúmenes aplicación: 5064-7W: 560 lm



IP44

Ref. 5064-01-7W 4000K P.V. 14,60 €

OPCIONES **WiFi** **E**

Ø145 x 85 mm
Ø125 mm



5064-01-12W

01: Blanco

Neutro



Lúmenes chip: 5064-12W: 1400 lm
Lúmenes aplicación: 5064-12W: 1150 lm



IP44

Ref. 5064-01-12W 4000K P.V. 23,92 €

OPCIONES **WiFi** **E**

Ø245 x 84 mm
Ø200 mm



5064-01-25W

01: Blanco

Neutro



Lúmenes chip: 5064-25W: 2500 lm
Lúmenes aplicación: 5064-25W: 2350 lm



IP44

Ref. 5064-01-25W 4000K P.V. 38,50 €

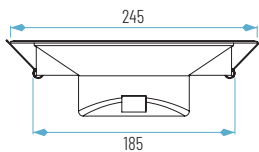
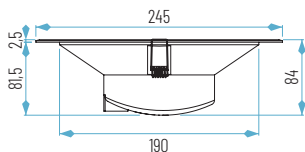

01. EMPOTRAR - DOWNLIGHTS

CONALUX LED

DOWNLIGHTS LED TRIAC

TÉCNICO DE EMPOTRAR



Ø112 x 38 mm
Ø90 mm



01: Blanco

IP44

Neutro

Triac-AC



Lúmenes chip: 5067-7W: 770 lm
Lúmenes aplicación: 5067-7W: 570 lm

5067-01-7W

Ref. 5067-01-7W 4000K P.V. 13,70 €

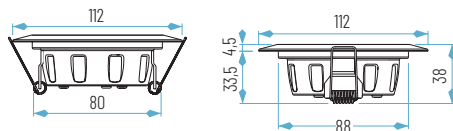

Ø180 x 38 mm
Ø150 mm



01: Blanco

IP44

Neutro

Triac-AC



Lúmenes chip: 5067-15W: 1320 lm
Lúmenes aplicación: 5067-15W: 1200 lm

5067-01-15W

Ref. 5067-01-15W 4000K P.V. 25,80 €

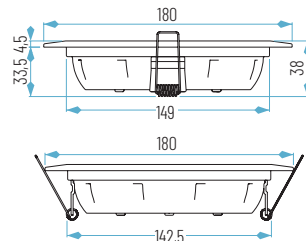

Ø235 x 38 mm
Ø200 mm



01: Blanco

IP44

Neutro

Triac-AC



Lúmenes chip: 5067-25W: 2750 lm
Lúmenes aplicación: 5067-25W: 2100 lm

5067-01-25W

Ref. 5067-01-25W 4000K P.V. 33,50 €

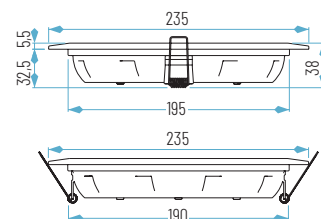

OPCIONES **12V/24V** **Wi Fi** **REG** **E**

90 x 90 x 70 mm
80 x 80 mm



5086-01/ 6W

Ref. 5086-01-6W-4K P.V. 18,50 €

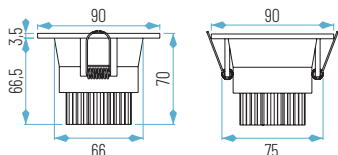

01: Blanco

Neutro



Lúmenes chip: 5086-6W: 580 lm
Lúmenes aplicación: 5086-6W: 340 lm

OPCIONES **12V/24V** **Wi Fi** **REG** **E**

135 x 135 x 75 mm
125 x 125 mm



5086-01/ 12W

Ref. 5086-01-12W-4K P.V. 25,40 €

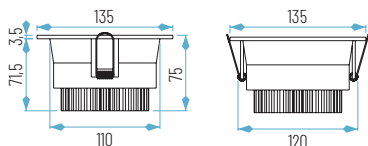

01: Blanco

Neutro



Lúmenes chip: 5086-12W: 800 lm
Lúmenes aplicación: 5086-12W: 674 lm

OPCIONES **12V/24V** **Wi Fi** **REG** **E**

155 x 155 x 75 mm
135 x 135 mm



5086-01/ 20W

Ref. 5086-01-20W-4K P.V. 33,20 €

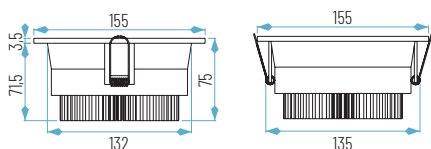

01: Blanco

Neutro



Lúmenes chip: 5086-20W: 1500 lm
Lúmenes aplicación: 5086-20W: 1125 lm

01. EMPOTRAR - DOWNLIGHTS

CONALUX LED

DOWNLIGHTS LED SMD

TÉCNICO DE EMPOTRAR



Ø90 x H70 mm
Ø80 mm



01: Blanco

Cálido

Neutro



Lúmenes chip: 5087-6W: 580 lm
Lúmenes aplicación: 5087-6W: 270 lm

5087-01/ 6W

Ref.	P.V.
5087-01-6W 3000K	21,40 €
5087-01-6W 4000K	21,40 €

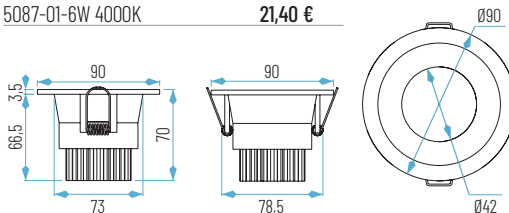

Ø135 x H75 mm
Ø125 mm



01: Blanco

Cálido

Neutro



Lúmenes chip: 5087-12W: 800 lm
Lúmenes aplicación: 5087-12W: 540 lm

5087-01/ 12W

Ref.	P.V.
5087-01-12W 3000K	29,20 €
5087-01-12W 4000K	29,20 €

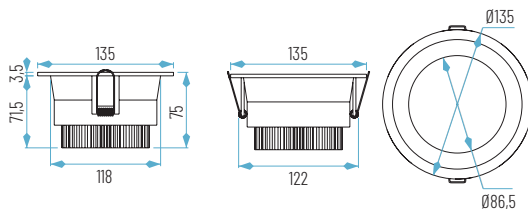

Ø155 x H90 mm
Ø140 mm



01: Blanco

Cálido

Neutro



Lúmenes chip: 5087-20W: 1500 lm
Lúmenes aplicación: 5087-20W: 894 lm

5087-01/ 20W

Ref.	P.V.
5087-01-20W 3000K	37,49 €
5087-01-20W 4000K	37,49 €

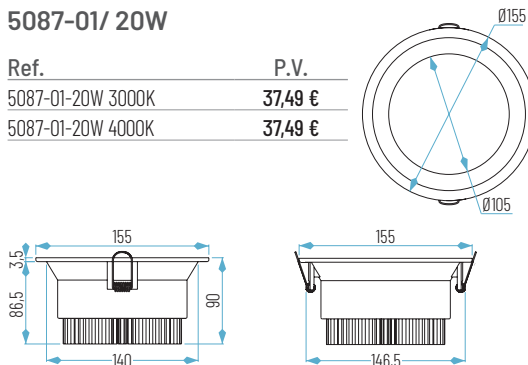

OPCIONES



Ø280 x H110 mm
Ø235 mm



5065-01-30W

Ref.	P.V.
5065-01-30W 4000K	78,90 €
5065-01-30W 4K UGR 19	82,90 €

OSRAM

01: Blanco

Neutro



5065-01-30W 4000K

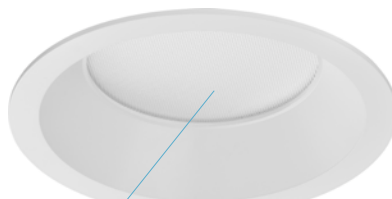

5065-01-30W 4K

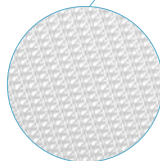

Lúmenes chip: 5065-30W: 3264 lm
Lúmenes aplicación: 5065-30W: 3100 lm

Lúmenes chip: 5065-30W UGR: 3100 lm
Lúmenes aplicación: 5065-30W UGR: 2670 lm

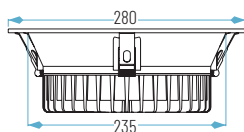
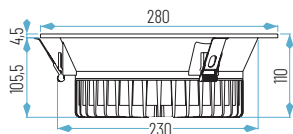

RESULTADOS FOTOMÉTRICOS

para la referencia 5065

para la referencia 5065 UGR

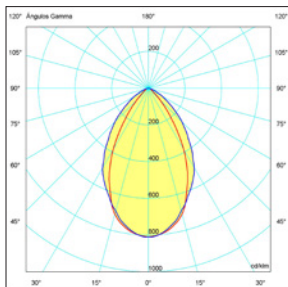
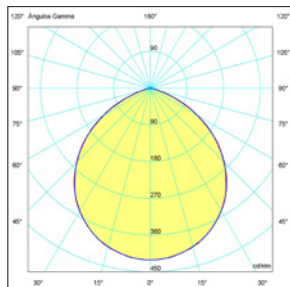

 OPCIONES **12V/24V** **WiFi** **REG** **E**
 01: Blanco

 Cálido

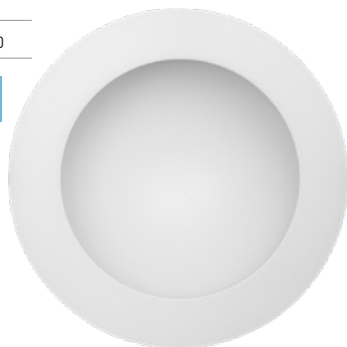
 Neutro

UGR 17

5099 12W
 Ø145x 50 mm
 Ø135 mm



5099-12W GALAXY

Lúmenes aplicación: 5099-12W: 624 lm

Ref.	T.ª Color	P.V.
5099-12W	3K o 4K	26,04 €

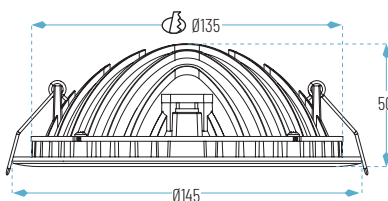

5099-24W GALAXY

Lúmenes aplicación: 5099-24W: 1256 lm

Ref.	T.ª Color	P.V.
5099-24W	3K o 4K	46,31 €

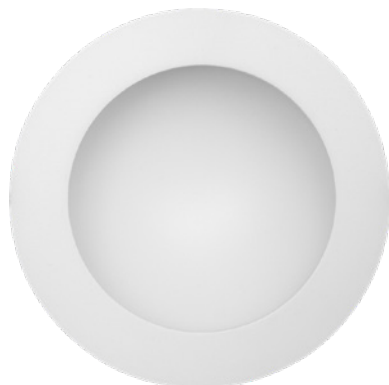
UGR 17

5099 24W
 Ø230x70 mm
 Ø205 mm

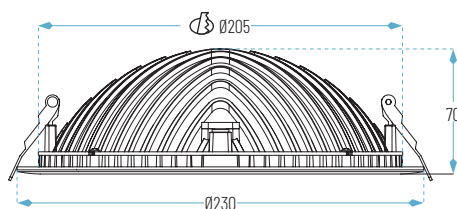

OPCIONES **12V/24V** **Wi Fi** **REG** **E**

Ø95 x 60 mm
Ø75 mm

UGR 19 **Flicker Free** **100% Ra** **CE** **RoHS** **IP 20** **FP >0.9** **CRI >80**

5068-01-7W

Ref.	T.ª Color	P.V.
5068-01-7W	3K o 4K	17,50 €
5068-19-7W	3K o 4K	17,50 €

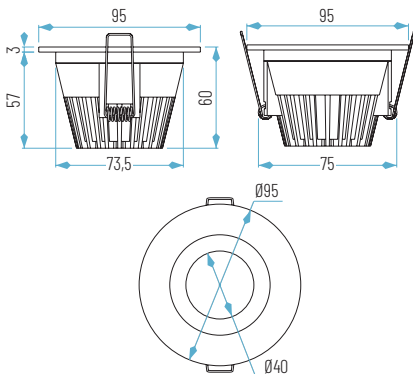

OSRAM

- Exterior
 01: Blanco
 19: Negro
- Interior
 01: Blanco
 19: Negro
 05: Cromo
 Cálido
 Neutro



5068-7W-R01

Lúmenes chip: 5068-7W: 875 lm
Lúmenes aplicación: 5068-7W: 560 lm

Reflector blanco incluido.
Opción en cromo o en negro



5068-7W-R05

5068-7W-R19



OPCIONES **12V/24V** **Wi Fi** **REG** **E**

Ø140x 80 mm
Ø120 mm

UGR 19 **Flicker Free** **100% Ra** **CE** **RoHS** **IP 20** **FP >0.9** **CRI >80**

5068-01-15W

Ref.	T.ª Color	P.V.
5068-01-15W	3K o 4K	34,90 €
5068-19-15W	3K o 4K	34,90 €

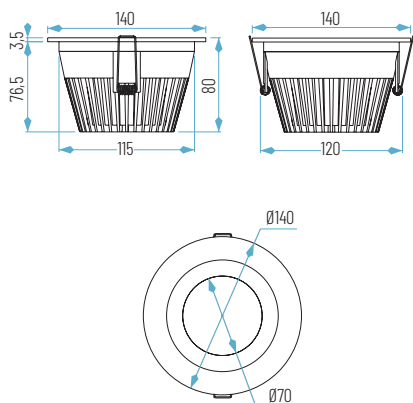

OSRAM

- Exterior
 01: Blanco
 19: Negro
- Interior
 01: Blanco
 19: Negro
 05: Cromo
 Cálido
 Neutro



5068-15W-R01

Lúmenes chip: 5068-15W: 1875 lm
Lúmenes aplicación: 5068-15W: 1600 lm

Reflector blanco incluido.
Opción en cromo o en negro



5068-15W-R05

5068-15W-R19



Ø170x 100 mm
Ø145 mm



Interior

□ 01: Blanco

■ 19: Negro

■ 05: Cromo

● Cálido

● Neutro



Exterior

□ 01: Blanco

■ 19: Negro

OSRAM

5068-01-25W

Lúmenes chip: 5068-25W: 3125 lm
Lúmenes aplicación: 5068-25W: 2000 lm

Ref.	T. ^a Color	P.V.
5068-01-25W	3K o 4K	48,18 €
5068-19-25W	3K o 4K	48,18 €



5068-25W-R01

Reflector blanco incluido.
Opción en cromo o en negro



5068-25W-R05



5068-25W-R19

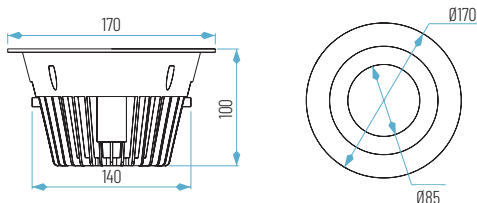

Ø225 x 120 mm
Ø205 mm



Interior

□ 01: Blanco

■ 19: Negro

■ 05: Cromo

● Cálido

● Neutro



Exterior

□ 01: Blanco

■ 19: Negro

OSRAM

5068-01-40W

Lúmenes chip: 5068-40W: 5000 lm
Lúmenes aplicación: 5068-40W: 3200 lm

Ref.	T. ^a Color	P.V.
5068-01-40W	3K o 4K	67,16 €
5068-19-40W	3K o 4K	67,16 €



5068-40W-R01

Reflector blanco incluido.
Opción en cromo o en negro



5068-40W-R05



5068-40W-R19

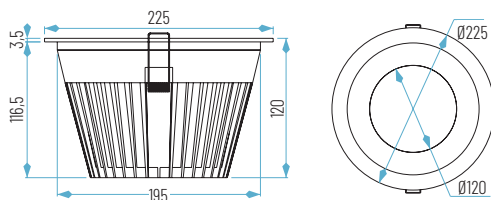





OPCIONES **12V/24V** **Wi Fi** **REG** **E**

Ø90x 47 mm
Ø75 mm

Flicker Free **UGR 19** **0.9** **CE** **RoHS** **IP 65** **CRI >80**

ARIES 5062-7W-4K

Lúmenes chip: ARIES-7W: 975 lm
Lúmenes aplicación: ARIES-7W: 700 lm

Ref.	Driver	P.V.
5062-7W-01-4K	IP20	38,70 €
5062-7W-01-4K	IP65	47,70 €

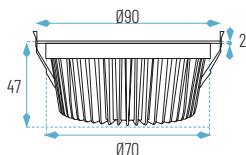

OSRAM

IP65

01: Blanco

Neutro



OPCIONES **12V/24V** **Wi Fi** **REG** **E**

Ø225 x 90 mm
Ø200 mm

Flicker Free **UGR 19** **0.9** **CE** **RoHS** **IP 65** **FP >0.9** **CRI >80**

ARIES 5062-30W-4K

Lúmenes chip: ARIES-30W: 4050 lm
Lúmenes aplicación: ARIES-30W: 3000 lm

Ref.	Driver	P.V.
5062-30W-01-4K	IP20	114,90 €
5062-30W-01-4K	IP65	147,45 €

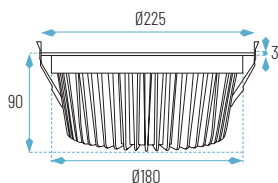

OSRAM

IP65

01: Blanco

Neutro



