

# ZEMPER

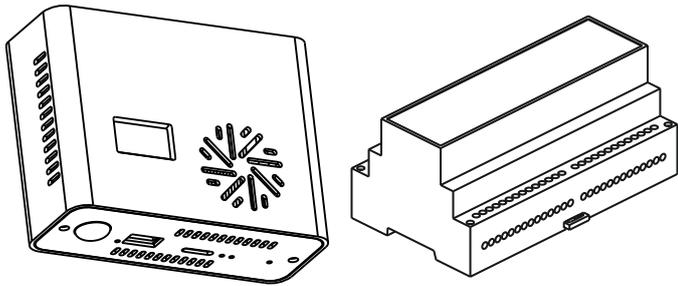

## CSZ003

Central SmartZ + Fuente Alimentación / SmartZ Control Unit / Centrale SmartZ / Smartz-besturingseenheid / SmartZ-kontrollenhet / Unità di controllo SmartZ

1 Presentación / Presentation / Présentation / Presentatie / Presentasjon / Presentazione

Conforme a / According to / Conforme à / I henhold til / Volgens / Conforme a EN60598-2-22

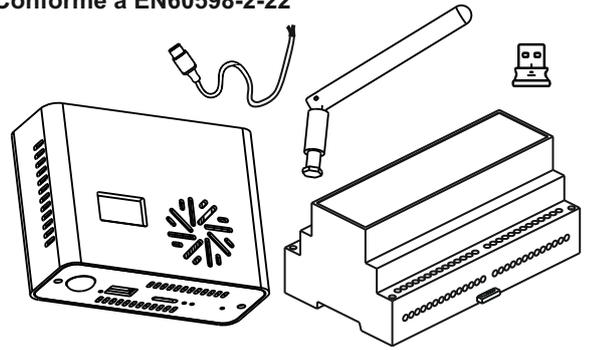

IMPORTANTE / IMPORTANT / IMPORTANT / BELANGRIJK / VIKTIG / IMPORTANTE

PARA EL MANUAL DE INSTRUCCIONES COMPLETO, CONSULTAR EL CÓDIGO QR:  
 FOR THE COMPLETE INSTRUCTION MANUAL, SEE THE QR CODE:  
 POUR LE MANUEL D'INSTRUCTIONS COMPLET, VOIR LE QR CODE:  
 ZIE DE QR-CODE VOOR DE COMPLETE HANDLEIDING:  
 SE QR-KODEN FOR DEN KOMPLETTE BRUKSANVISNINGEN:  
 PER IL MANUALE ISTRUZIONI COMPLETO VEDI IL QR CODE:



2 Conexiones / Connections / Connexions / Aansluitingen / Tilkoblinger / Connessioni

**SAI002:** Puertos 26 y 27: Salida de 5V (+,-) conectada a la entrada tipo C de la central  
 Puertos 1 y 3 (L y N): Entrada para alimentación principal 230V 50Hz conectada a red  
**Central:** Puerto Ethernet conectado  
 Antena BLE

**SAI002:** Ports 26 and 27: 5V output (+,-) connected to the type C input of the control panel.  
 Ports 1 and 3 (L and N): Main power input 230V 50Hz connected to the mains.  
**Control unit:** Ethernet port connected  
 BLE antenna

**SAI002:** Ports 26 et 27 : sortie 5V (+,-) connectée à l'entrée de type C du panneau de contrôle.  
 Ports 1 et 3 (L et N) : Entrée d'alimentation principale 230V 50Hz connectée au réseau.  
**Unité de contrôle :** Port Ethernet connecté  
 Antenne BLE

**SAI002:** Poorten 26 en 27: 5V-uitgang (+,-) aangesloten op de type C-ingang van het bedieningspaneel.  
 Poorten 1 en 3 (L en N): Voedingsingang 230V 50Hz aangesloten op het lichtnet.  
**Bedieningseenheid:** Ethernetpoort aangesloten  
 BLE-antenne

**SAI002:** Port 26 og 27: 5V-utgang (+,-) koblet til type C-ingangen på kontrollpanelet.  
 Port 1 og 3 (L og N): Hovedstrøminggang 230 V 50 Hz koblet til strømnettet.  
**Kontrollenhet:** Ethernet-port tilkoblet  
 BLE-antenne

**SAI002:** Porte 26 e 27: uscita 5V (+,-) collegata all'ingresso di tipo C del pannello di controllo.  
 Porte 1 e 3 (L e N): ingresso alimentazione principale 230V 50Hz collegato alla rete.  
**Unità di controllo:** porta Ethernet collegata  
 Antenna BLE

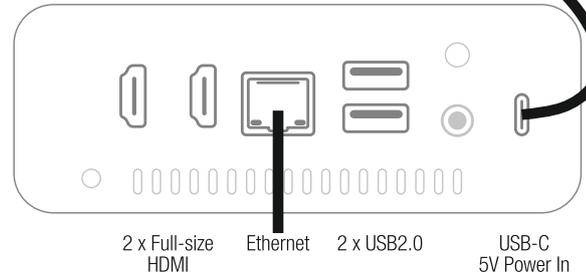
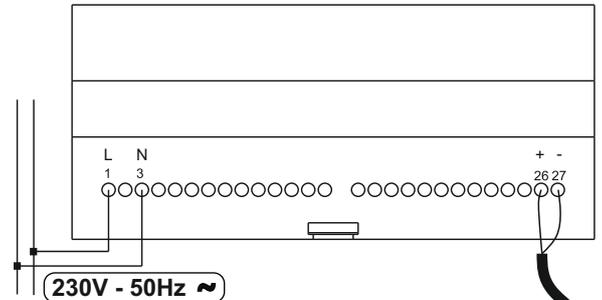

2 x Full-size HDMI    Ethernet    2 x USB2.0    USB-C 5V Power In

3 Dimensiones / Dimensions / Dimensions / Dimensies / Dimensjoner / Dimensioni

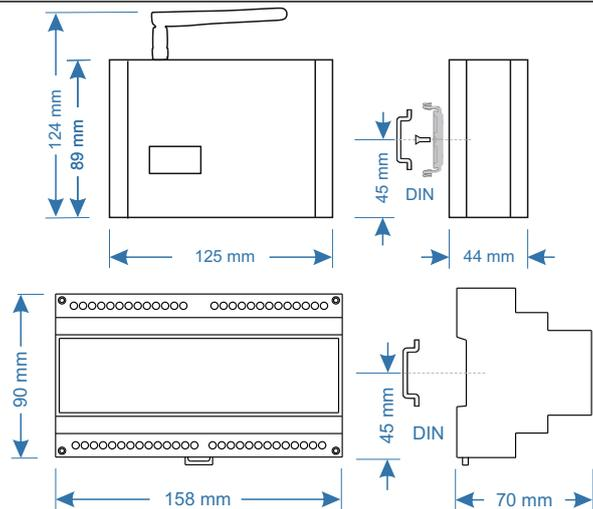

4 Cambio de batería / Battery change / Remplacement de la batterie / Batterij vervangen / Utskifting av batteri / Sostituzione della batteria

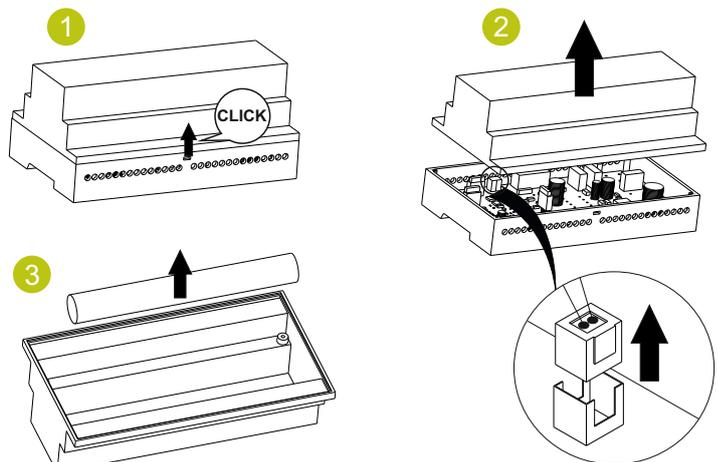

5 Instalación de las luminarias / Installation of the luminaires / Installation des luminaires / Installatie van de armaturen / Installasjon av armaturere / Installazione degli apparecchi di illuminazione

- 1 Instalar las luminarias, conectándolas únicamente a tensión de red.  
(Ver "Instrucciones de luminarias").  
Install the luminaires, connecting them only to the mains power.  
(See "Luminaire Instructions").  
Installer les luminaires, en les connectant uniquement à la tension du réseau.  
(Voir "Instructions des luminaires").  
Installeer de armaturen en sluit ze alleen aan op het netstroom.  
(Zie "Instructies voor armaturen").  
Installer armaturere, og koble dem kun til nettspenning.  
(Se "Armaturinstruksjoner").  
Installare gli apparecchi di illuminazione, collegandoli solo alla tensione di rete.  
(Vedere "Istruzioni per apparecchi di illuminazione").

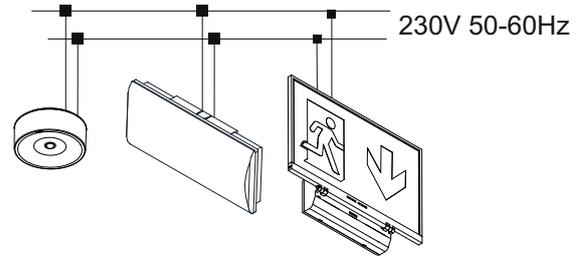

- 2 Anotar número de serie de cada luminaria sobre su ubicación de instalación en el plano.  
Note the serial number of each luminaire on its installation location on the plan.  
Noter le numéro de série de chaque luminaire sur son lieu d'installation sur le plan.  
Noteer het serienummer van elke armatuur op de installatieplaats op de plattegrond.  
Noter serienummeret til hver armatur på installasjonsstedet på planen.  
Annotare il numero di serie di ciascun apparecchio nella sua posizione di installazione sulla planimetria.

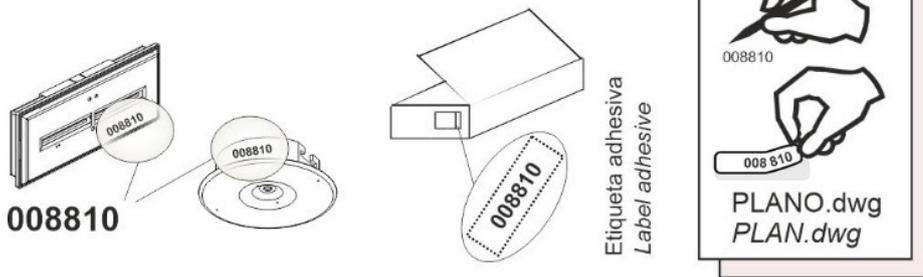

6 Comunicaciones sistema SmartZ / SmartZ system communications / Communications du système SmartZ / SmartZ-systeemcommunicatie / SmartZ-systemkommunikasjon / Comunicazioni del sistema SmartZ

